



EMS Installation Guide

ENGLISH VERSION

wallbox ™

Index

PURPOSE AND SCOPE OF THE DOCUMENT	3
INSTALLATION	4
Getting started	4
Pulsar Plus	6
Power Boost and Eco-Smart	6
Power Sharing	12
Dynamic Power Sharing	18
Commander 2	26
Power Boost and Eco-Smart	26
Power Sharing	32
Dynamic Power Sharing	38
Copper SB	46
Power Boost and Eco-Smart	46
Power Sharing	52
Dynamic Power Sharing	58
Quasar	66
V2H	66
Pulsar Max & Pulsar Pro	72
Power Boost and Eco-Smart	74
Power Sharing	80
Dynamic Power Sharing	86
CONFIGURATION	94
Power Boost	94
Eco-Smart	98
V2H	103
Power Sharing	109
Dynamic Power Sharing	114
APPENDIX	119
EM330 Configuration (Only for 400 A and 600 A clamps)	120
How to install N1 CT	121
How to install P1 Port	122
Installing Dynamic Power Sharing with 4 chargers	124

ENERGY MANAGEMENT SOLUTIONS

Purpose and Scope of the Document

The purpose of this document is to outline the instructions for the installation of the Energy Management Solutions.

To install an MID meter, refer to the relevant **Installation Guide**.

INSTALLATION

Getting started

Important Notes

- A.** Install the charger following the instructions listed in the chargers' **Installation Guide**. Refer to the user guide on the **Wallbox Academy** page for more information.
- B.** Only energy meters provided by Wallbox are compatible with Wallbox chargers.
- C.** Installations should be performed only by qualified personnel in accordance with applicable local regulations.
- D.** Update the Wallbox charger with the latest software version before installing the energy meter. Refer to the instructions for updating the charger on the **Wallbox Academy** page for more information.
- E.** Ensure that the charger is powered off and its cover is removed before connecting the energy meter. Close the charger properly after the installation.
- F.** After installing the charger, connect the energy meter before closing your charger. In case the energy meter is to be connected to a previously installed charger, open it to connect the energy meter.

Inside the Package

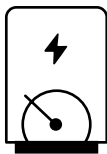

Energy Meter



Grommet

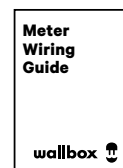

Meter Wiring Guide

INSTALLATION

Getting started

General Characteristics (Pulsar Plus, Pulsar Pro, Pulsar Max, Commander 2, Copper SB and Quasar)

	Power Boost	Eco-Smart	V2H	Power Sharing	Dynamic Power Sharing
Primary Chargers	1	1	1	1	1
Secondary Chargers	-	-	-	1-24	1-24
Communication protocol between chargers	-	-	-	CAN	CAN
Communication protocol between the Primary Charger and the Energy Meter	Modbus RTU	Modbus RTU	Modbus RTU	-	Modbus RTU
Maximum total length of wiring CAN network	-	-	-	250m	250m
Maximum length between the wiring of the Primary charger and the Energy Meter	500m	500m	500m	-	500m
Terminating Chargers	1	1	1	2	2
Maximum Phase Current configurable	Minimum between main switch rated (MCB) and the contract tariff	Minimum between main switch rated (MCB) and the contract tariff	Minimum between main switch rated (MCB) and the contract tariff	Minimum between main switch rated (MCB) and the contract tariff	Minimum between main switch rated (MCB) and the contract tariff
Configurable installation maximum current	Installation main switch rated current (MCB)	Installation main switch rated current (MCB)	Installation main switch rated current (MCB)	Installation main switch rated current (MCB)	Installation main switch rated current (MCB)
myWallbox	Super admin or admin account and basic subscription	Super admin or admin account and basic subscription	Super admin or admin account and basic subscription	Super admin or admin account and basic subscription	Super admin or admin account and standard subscription

Compatibility Power Meters

Choose the power meter that is compatible with your electrical network, you can find compatible meters in the Wallbox catalogue.

INSTALLATION WITH PULSAR PLUS
Power Boost and Eco-Smart

Tools

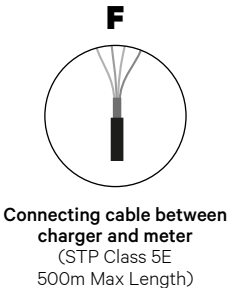
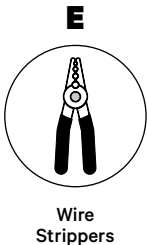
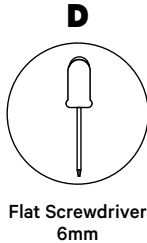
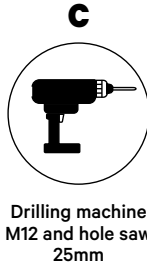
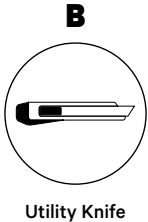
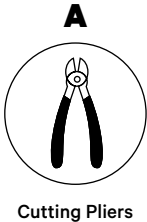

Refer to the **Pulsar Plus Installation Guide** to know more about the tools to install the charger.

INSTALLATION WITH PULSAR PLUS
Power Boost and Eco-Smart

Place the energy meter after the mains supply and before the fuse box.

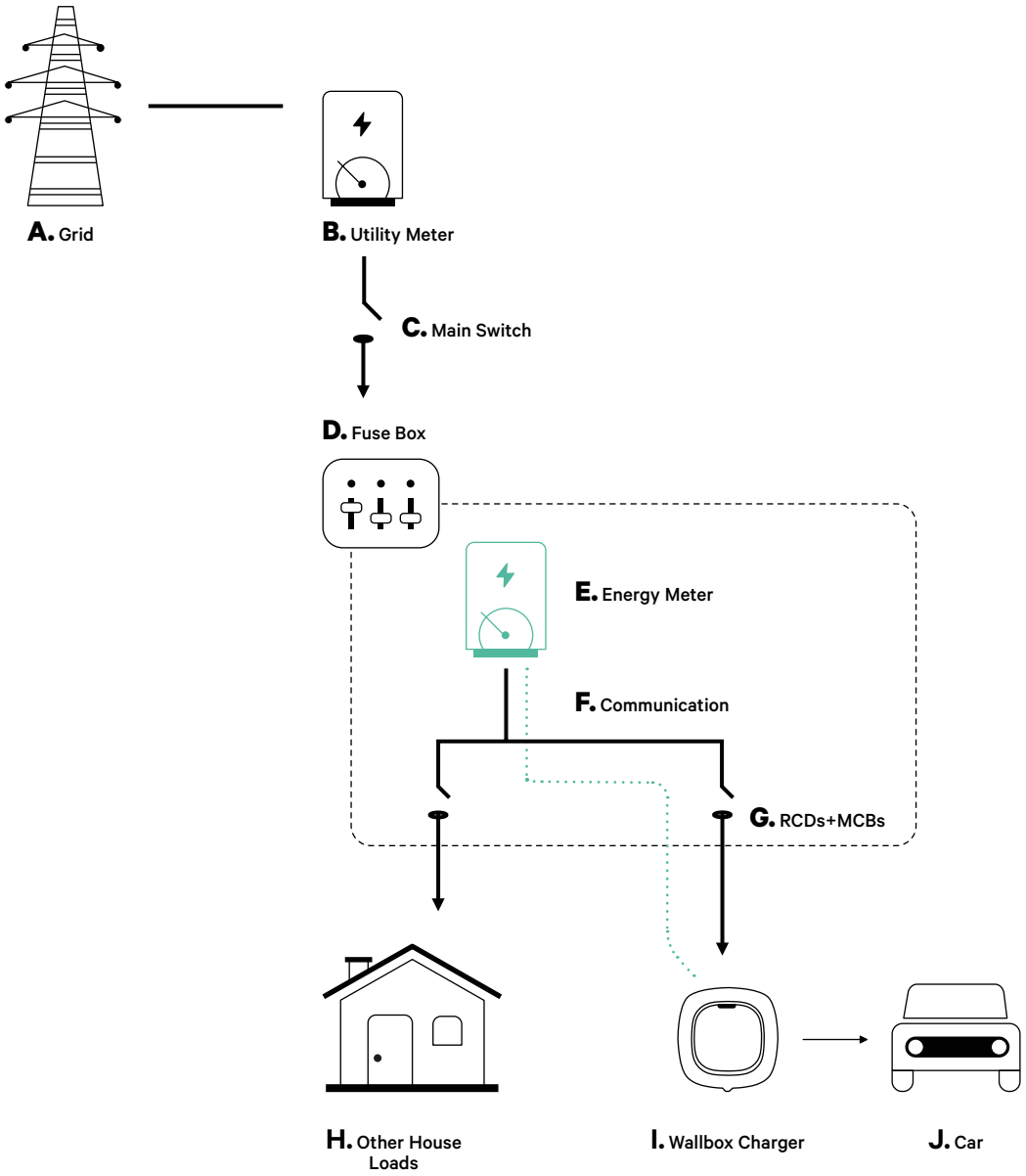

INSTALLATION WITH PULSAR PLUS Power Boost and Eco-Smart

Before Installation

- Ensure that the power is turned off during the installation.
- Separate the communication wires from the power ones.

Preparation

- 1.** Make a hole at the bottom of the charger using a M12 drill.

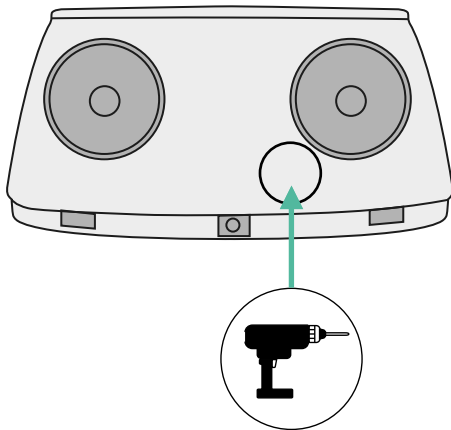

- 2.** With a flat screwdriver, make an incision in the grommet included in the meters package.

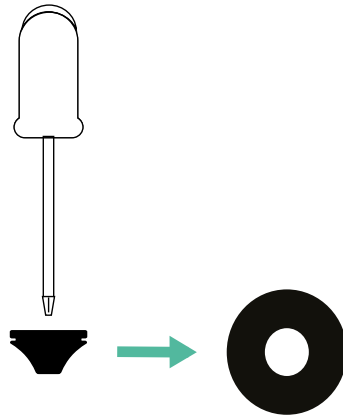

- 3.** Insert the **grommet** in the bottom hole of the charger.

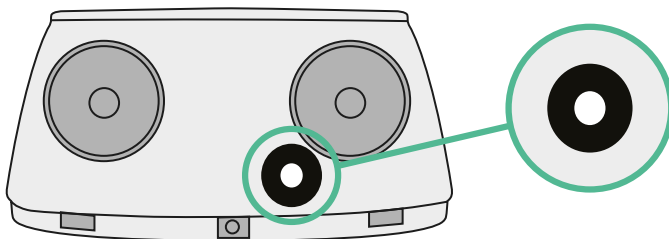

INSTALLATION WITH PULSAR PLUS

Power Boost and Eco-Smart

Pulsar Plus Installation Guide

Install the charger following the instructions in the **Pulsar Plus Installation Guide**.



Important

Ensure not to close the cover of the charger.

Communication wiring between the charger and the meter

- 1.** Keep the power turned off during the installation.
- 2.** Insert the communication wire through the grommet.

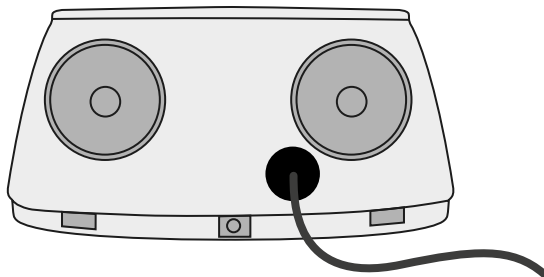

- 3.** Install the meter following the instructions in the Meter Wiring Guide included in the package.
- 4.** Wire the meter and the charger by following the relevant scheme below based on the model of your meter.



Important

It is mandatory to use an STP class 5E cable. Employ only 1 wire of each twisted pair and keep in mind that the communication wiring must not be more than 500m long.



Important

Insert only one cable for each grommet.

INSTALLATION WITH PULSAR PLUS Power Boost and Eco-Smart

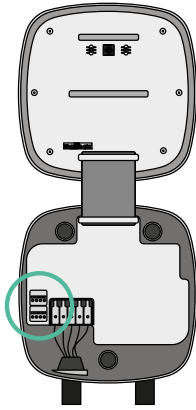

EM 112

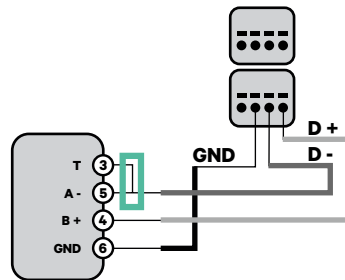

EM 340

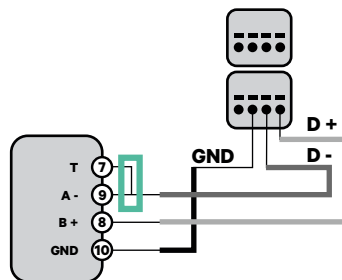

EM 330

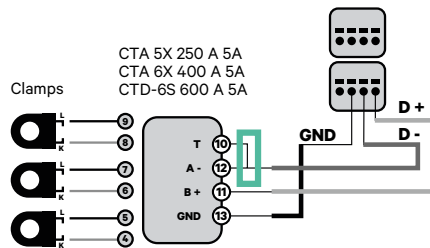
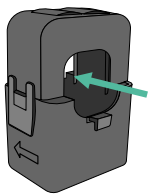

N1 CT

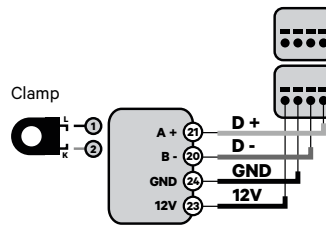

! For the EM330 configuration refer to the **Appendix**.

! For the N1CT installation, refer to the **Appendix**.

P1 Port

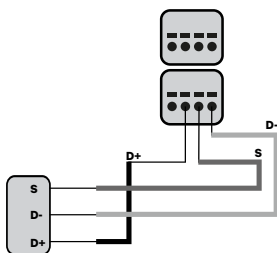

! For the P1 Port installation, refer to the **Appendix**.

SPM1-100-AC

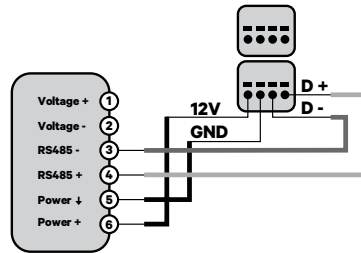

Pro MOD2

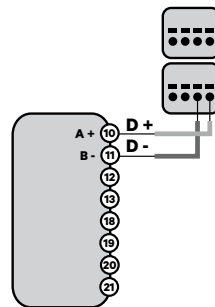

Pro 380 MOD

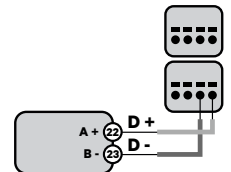

Important

Remember to check the Compatibility Table of each meter.

INSTALLATION WITH PULSAR PLUS

Power Boost and Eco-Smart

Terminating resistance activation and current selector configuration

1. Put the RS485 switch into position T.
2. Put the rotary switch into a position between 1 and 7, depending on the maximum current that can be supplied from the charging network.

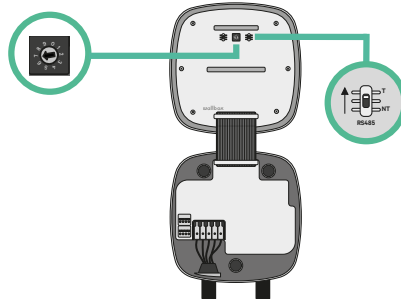

3. See the matrix below. This value must be equal or lower than the MCB protecting the Wallbox power line.

POSITION	0	1	2	3	4	5	6	7	8	9
CURRENT (A)	R	6	10	13	16	20	25	32	R	R

Note: Only Max Current > 6A per phase is accepted for a correct performance. In case of doubt, contact Wallbox Service.

4. Close the cover of the charger following the instructions in the charger's **Installation Guide**.

INSTALLATION WITH PULSAR PLUS

Power Sharing

Tools

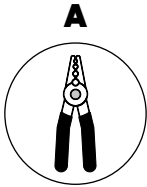

Wire Strippers

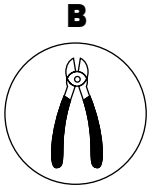

Cutting Pliers

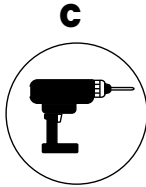

Drilling machine
M12 and hole saw
25mm

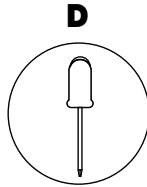

Flat Screwdriver

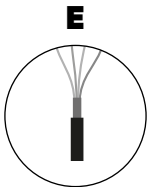

Connecting cable between
charger and charger
(UTP CAT 5E 250m
Max. Length)

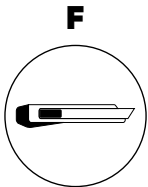

Cutter

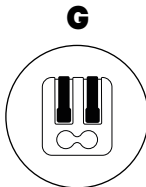

Two pole lever
connectors
(for small
communication
wires)

Refer to the **Pulsar Plus Installation Guide** to know more about the tools to install the charger.

INSTALLATION WITH PULSAR PLUS

Power Sharing

Before Installation

- Ensure that the power is turned off during the installation.
- Separate the communication wires from the power ones.

Preparation

- 1.** Make a hole at the bottom of the charger using a M12 drill.

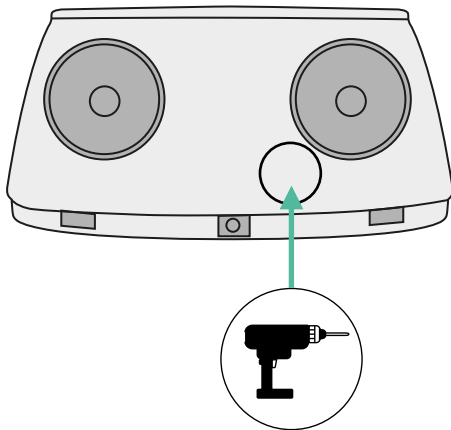

- 2.** With a flat screwdriver, make an incision in the grommet included in the meter's package.

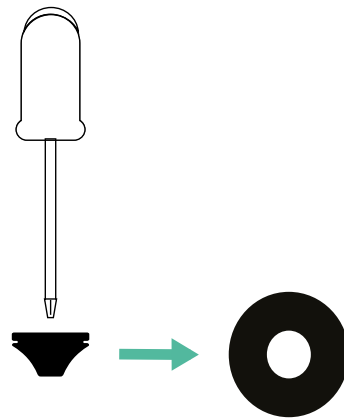

- 3.** Insert the **grommet** in the bottom hole of the charger.

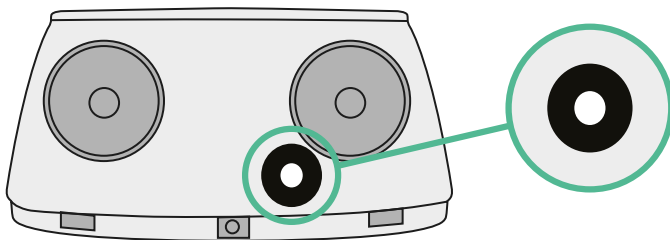

Pulsar Plus Installation

Install the charger following the instructions in the [Pulsar Plus Installation Guide](#).



Important

Ensure not to close the cover of the charger.

INSTALLATION WITH PULSAR PLUS

Power Sharing

Wiring the system

1. Ensure that the power is turned off during the installation.
2. Insert the communication wire (UTP 5E cable) through the grommet.

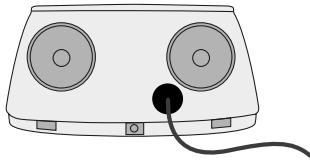

3. Check the position of CAN - L and CAN - H indicated above the connector. **Remember:** the sequence in the connector can be different depending on each product.
4. Once located the connector, start cabling the primary charger (the first of the chain). Use a UTP 5E cable (a pair), then, insert one of the cables in CAN-L and the other in CAN-H. After, connect the other chargers of the chain following the scheme below. As you may notice, all the chargers have CAN-L and a CAN-H inputs and outputs, except for the first and the last ones.

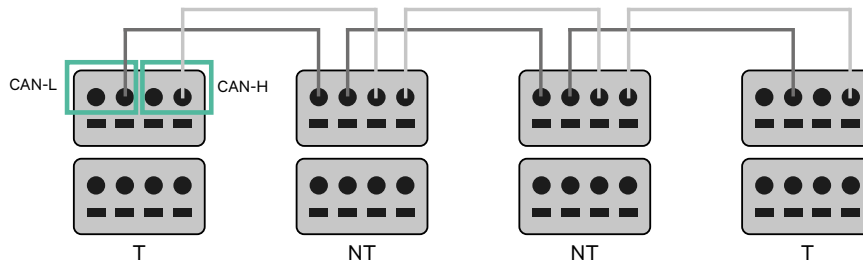

Important

- Make sure to connect each CAN-L to the respective CAN-L connector of all the chargers. Do the same for CAN-H.
- Power sharing works up to 25 chargers for each installation. Among them, one is primary and 24 are secondary. The maximum distance the communication wiring can reach is 250m.

	CAN-L	CAN-H
CAN-L	✓	×
CAN-H	×	✓

Note: Only Max Current > 6A per phase is accepted for a correct performance. In case of doubts, contact Wallbox Service.

Refer to the **Installation Guide** for more information.

INSTALLATION WITH PULSAR PLUS

Power Sharing

Terminating settings

1. Once the cabling is completed, you need to activate the termination resistors. The first and the last charger will always be terminating (T) with non terminating (NT) chargers between them.

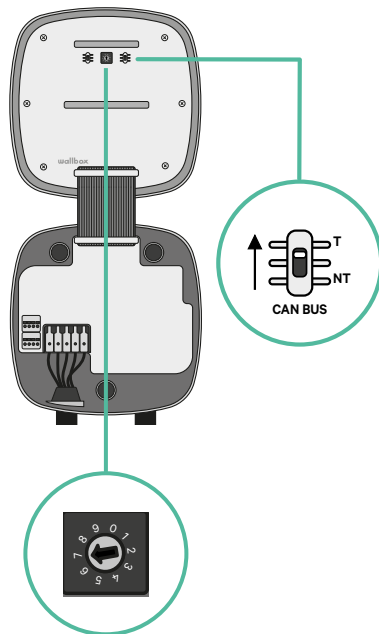
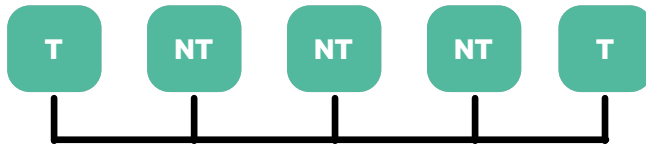

INSTALLATION WITH PULSAR PLUS Power Sharing

2. Once the termination resistors are set up, place the current selector of each charger following the information. The first charger of the chain is the primary charger, the others are secondary.

The **primary charger** will be set on position 8 or 9.

The **secondary chargers** will be set on position 0.

POSITION	0	1	2	3	4	5	6	7	8	9
MAX CURRENT	*PS	6	10	13	16	20	25	32	*PS	*PS

3. To ensure a proper set-up the measured **resistance between CAN-H and CAN-L must be near to 60 Ohms**. If it differs from that, recheck the proper wiring and the T/NT configuration.

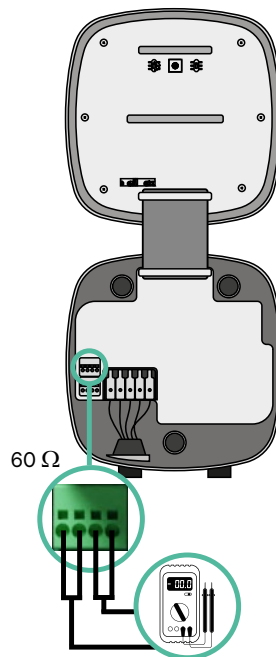

4. Close the cover of your charger by following the instructions in the respective **Installation Guide**.

INSTALLATION WITH PULSAR PLUS

Power Sharing

Adding chargers in the future:

If you anticipate adding chargers to the system in the future, there are two ways you can prepare the system now to make it ready for Power Sharing.

Option 1: Place a bus disconnecter to accommodate future chargers as shown in the option 1 wiring scheme below. This option avoids the need of reopening the existing chargers and hence it is the recommended option.

Option 2: Truncate the existing bus to add new charger(s) as shown in the option 2 wiring scheme below.

1. Open the charger following the installation guide of your Pulsar Plus charger.
2. Set the terminating resistance into NT, make the communication wiring as explained above and then close the charger.



Important

New chargers may be placed anywhere physically in relation to the existing chargers as long as you follow these rules:

- You maintain the logic of the daisy chain.
- You respect the cabling polarity as described above under “Installation”.

Wherever a future added charger is placed, the most important rule to follow is the logic of the daisy chain. For example, in the image below, the new charger is placed before the Terminating charger on the right side of the daisy chain.

Option 1:

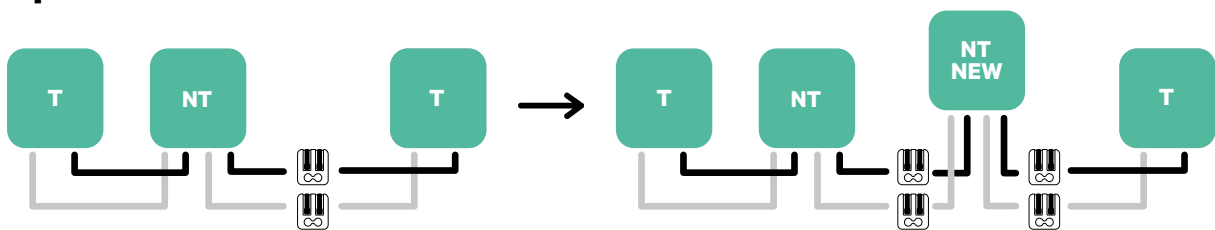

Option 2:

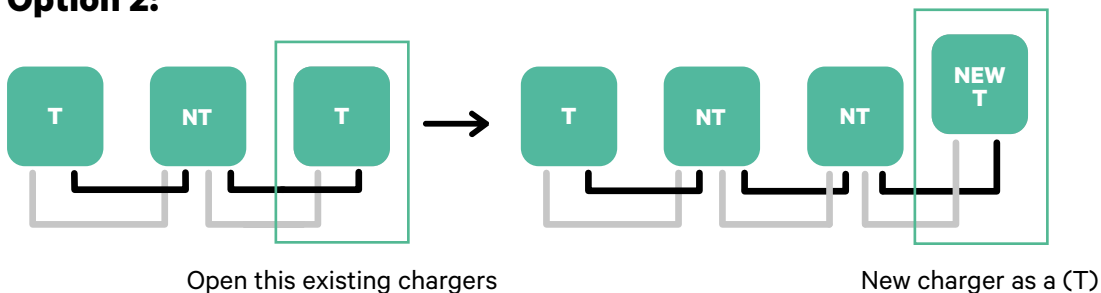

INSTALLATION WITH PULSAR PLUS

Dynamic Power Sharing

Tools

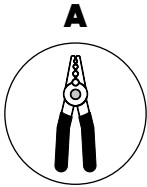

Wire Strippers

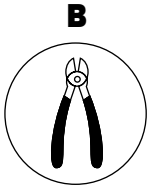

Cutting Pliers

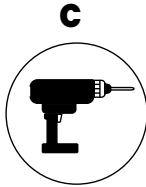

Drilling machine
M12 and hole saw
25mm

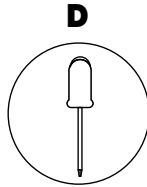

Flat Screwdriver

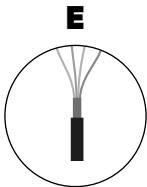

Connecting cable between
meter and charger
(STP Class 5E
500m Max Length)

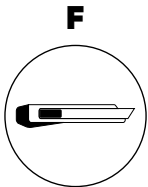

Cutter

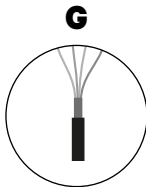

Connecting cable between
charger and charger
(UTP CAT 5E
250m Max Length)

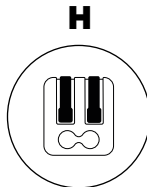

Two pole lever
connectors
(for small
communication
wires)

Refer to the **Pulsar Plus Installation Guide** to know more about the tools to install the charger.

INSTALLATION WITH PULSAR PLUS

Dynamic Power Sharing

Before Installation

- Ensure that the power is turned off during the installation.
- Separate the communication wires from the power ones.

Preparation

- 1.** Make a hole at the bottom of the charger using a M12 drill.

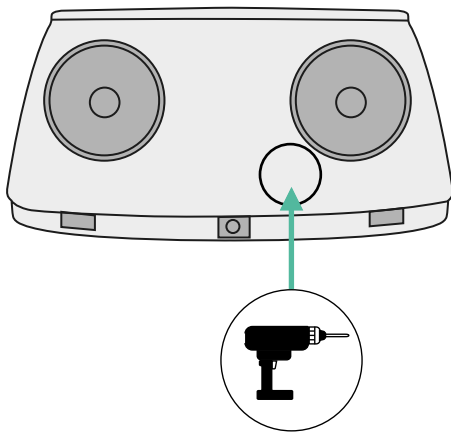

- 2.** With a flat screwdriver, make an incision in the grommet included in the meters package.

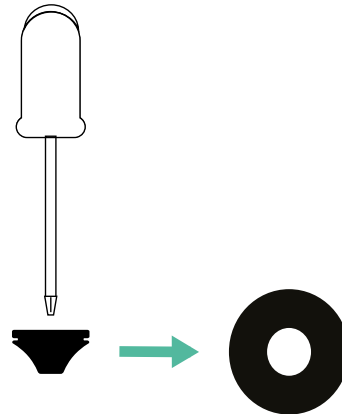

- 3.** Insert the **grommet** in the bottom hole of the charger.

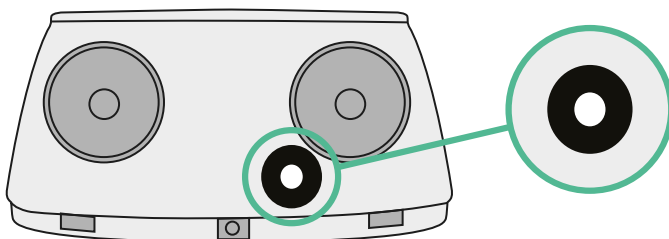

INSTALLATION WITH PULSAR PLUS

Dynamic Power Sharing

Pulsar Plus Installation Guide

Install the charger following the instructions in the **Pulsar Plus Installation Guide**.



Important

Ensure not to close the cover of the charger.

Communication wiring between the charger and the meter

- 1.** Keep the power turned off during the installation.
- 2.** Insert through the grommet the two communication wires, one for meter communication and the other one for communication between chargers.

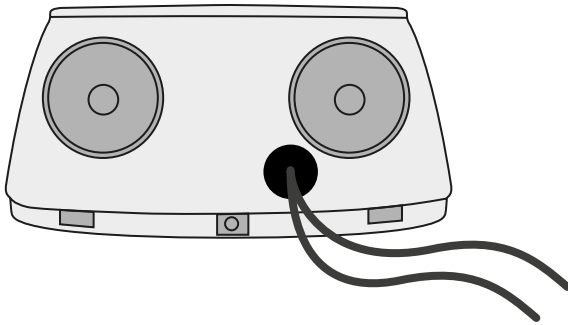

- 3.** Install the meter following the instructions in the Meter Wiring Guide included in the package.
- 4.** Wire the meter and the charger by following the relevant scheme below based on the model of your meter.



Important

It is mandatory to use an STP class 5E cable. Employ only 1 wire of each twisted pair and keep in mind that the communication wiring must not be more than 500m long.

INSTALLATION WITH PULSAR PLUS

Dynamic Power Sharing

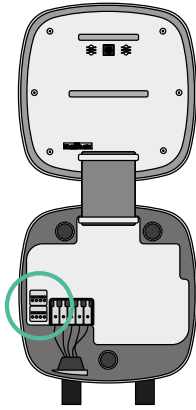

EM 112

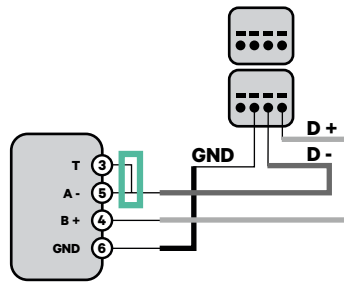

EM 340

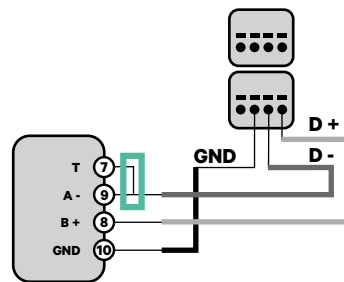

EM 330

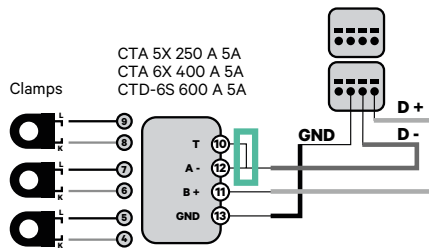
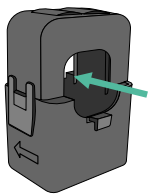

! For the EM330 configuration refer to the **Appendix**.

N1 CT

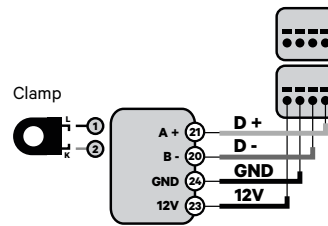

! For the N1CT installation, refer to the **Appendix**.

P1 Port

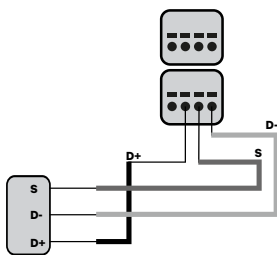

! For the P1 Port installation, refer to the **Appendix**.

SPM1-100-AC

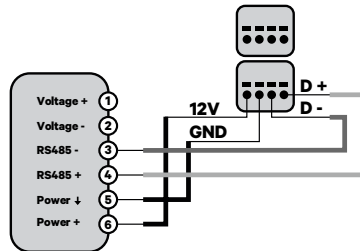

Pro MOD2

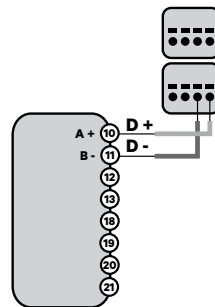

Pro 380 MOD

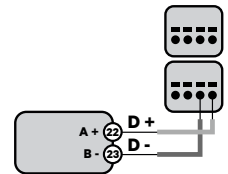

Important

Remember to check the Compatibility Table of each meter.

INSTALLATION WITH PULSAR PLUS

Dynamic Power Sharing

Wiring the system

1. Ensure that the power is turned off during the installation.
2. Check the position of CAN - L and CAN - H indicated above the connector.
Remember: the sequence in the connector can be different depending on each product.
3. Once located the connector, start cabling the primary charger (the first of the chain). Use a UTP 5E cable (a pair), then, insert one of the cables in CAN-L and the other in CAN-H. After, connect the other chargers of the chain following the scheme below. As you may notice, all the chargers have CAN-L and a CAN-H inputs and outputs, except for the first and the last ones.

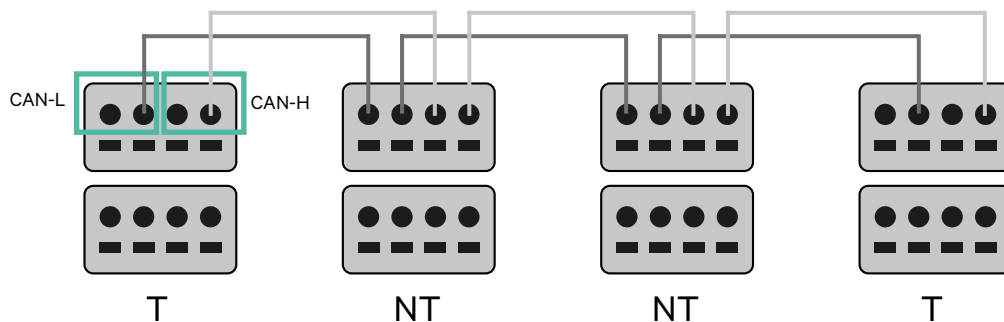

Important

- Make sure to connect each CAN-L to the respective CAN-L connector of all the chargers. Do the same for CAN-H.
- Power sharing works up to 25 chargers for each installation. Among them, one is primary and 24 are secondary. The maximum distance the communication wiring can reach is 250m.

	CAN-L	CAN-H
CAN-L	✓	✗
CAN-H	✗	✓

Note: Only Max Current > 6A per phase is accepted for a correct performance. In case of doubts, contact Wallbox Service.

INSTALLATION WITH PULSAR PLUS

Dynamic Power Sharing

Terminating settings

1. Once the cabling is complete, you need to activate the terminating resistors. First set up RS485 into T only for the charger that is connected into meter. Then set up the CAN BUS, the first and the last charger will always be terminating (T) with non terminating (NT) chargers between them.

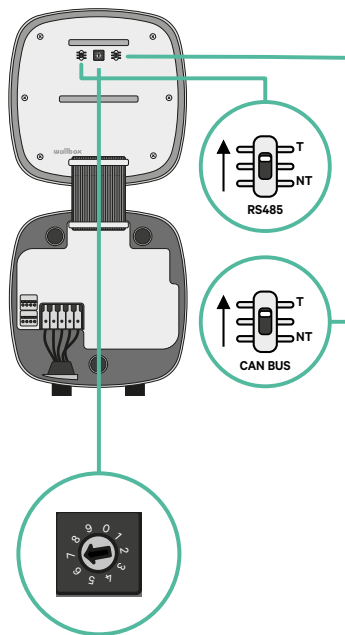
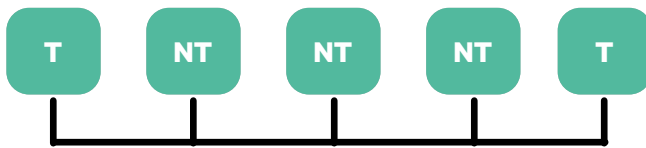

INSTALLATION WITH PULSAR PLUS

Dynamic Power Sharing

2. Once the termination resistors are set up, place the current selector of each charger following the information. The first charger of the chain is the primary charger, the others are secondary.

The **primary charger** will be set on position 8 or 9.

The **secondary chargers** will be set on position 0.

POSITION	0	1	2	3	4	5	6	7	8	9
MAX CURRENT	*PS	6	10	13	16	20	25	32	*PS	*PS

3. To ensure a proper set-up the measured **resistance between CAN-H and CAN-L must be near to 60 Ohms**. If it differs from that, recheck the proper wiring and the T/NT configuration.

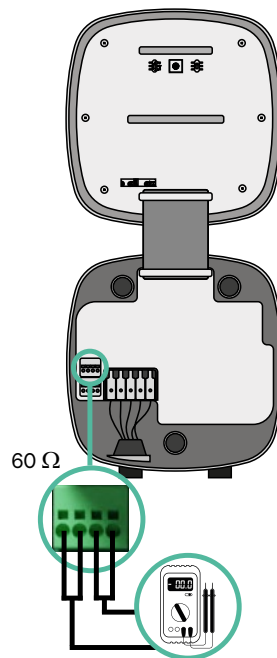

4. Close the cover of your charger by following the instructions in the respective **Installation Guide**.

INSTALLATION WITH PULSAR PLUS

Dynamic Power Sharing

Adding chargers in the future:

If you anticipate adding chargers to the system in the future, there are two ways you can prepare the system now to make it ready for Dynamic Power Sharing.

Option 1: Place a bus disconnecter to accommodate future chargers as shown in the option 1 wiring scheme below. This option avoids the need of reopening the existing chargers and hence it is the recommended option.

Option 2: Truncate the existing bus to add new charger(s) as shown in the option 2 wiring scheme below.

1. Open the charger following the installation guide of your Pulsar Plus charger.
2. Set the terminating resistance into NT, make the communication wiring as explained above and then close the charger.



Important

New chargers may be placed anywhere physically in relation to the existing chargers as long as you follow these rules:

- You maintain the logic of the daisy chain.
- You respect the cabling polarity as described above under “Installation”.

Wherever a future added charger is placed, the most important rule to follow is the logic of the daisy chain. For example, in the image below, the new charger is placed before the Terminating charger on the right side of the daisy chain.

Option 1:

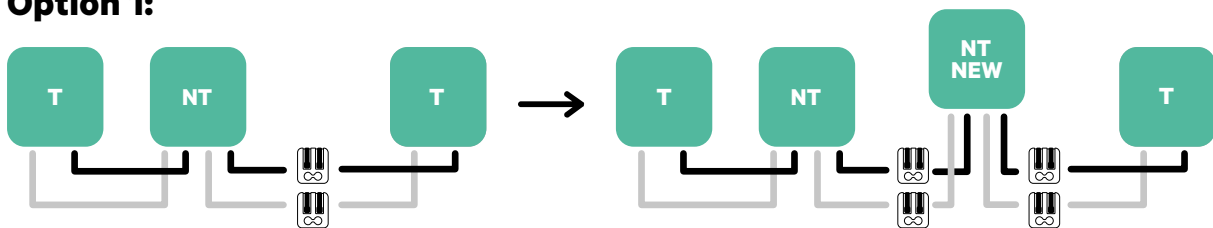

Option 2:

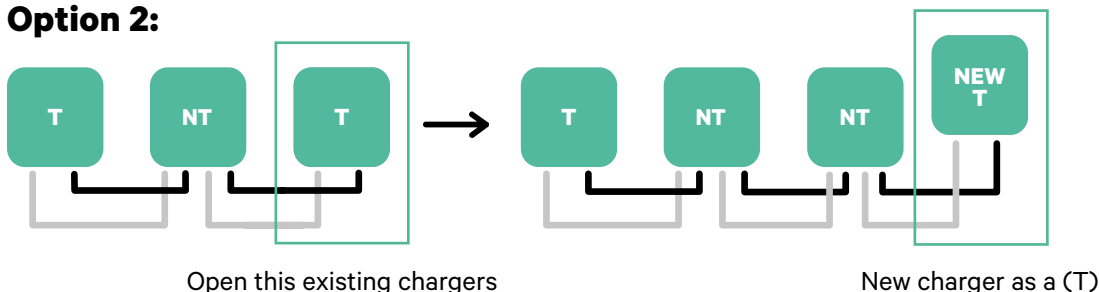

Once you finish the extension of the existing installation, continue with steps on the next page for setting up the chargers.

! To install Dynamic Power Sharing with four chargers, check the **Appendix**.

INSTALLATION WITH COMMANDER 2
Power Boost and Eco-Smart

Tools

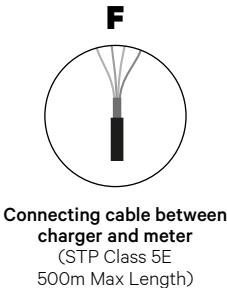
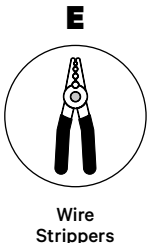
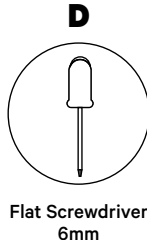
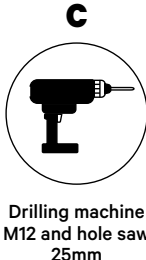
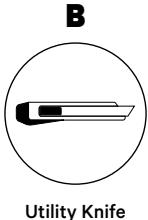
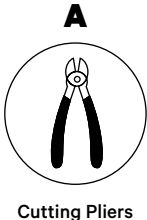

Refer to the **Commander 2 Installation Guide** to know more about the tools to install the charger.

INSTALLATION WITH COMMANDER 2
Power Boost and Eco-Smart

Place the energy meter after the mains supply and before the fuse box.

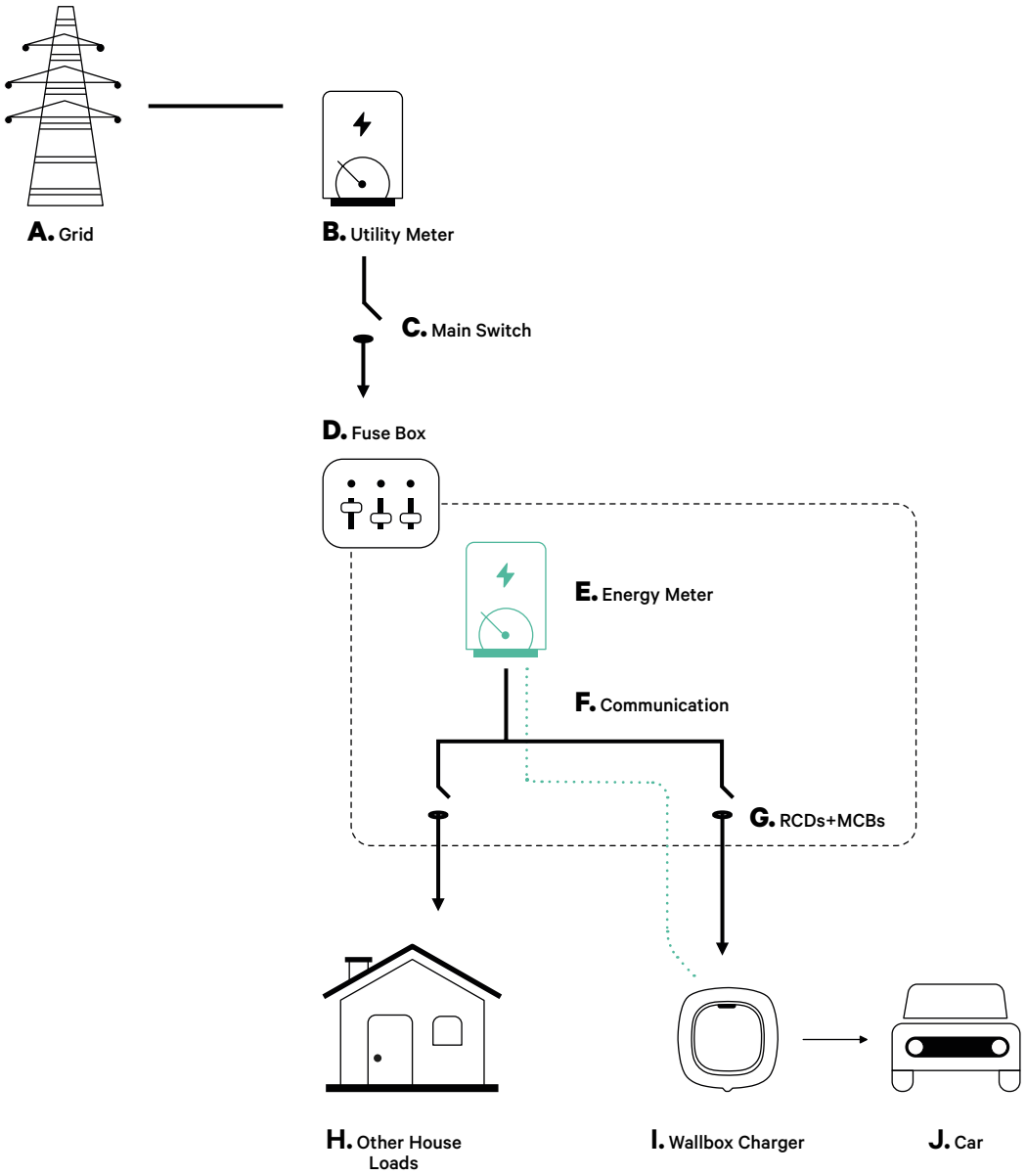

INSTALLATION WITH COMMANDER 2

Power Boost and Eco-Smart

Before Installation

- Ensure that the power is turned off during the installation.
- Separate the communication wires from the power ones.

Preparation

- 1.** Remove the plastic knock-out at the bottom of the charger using a 25mm drill bit hole saw drill.

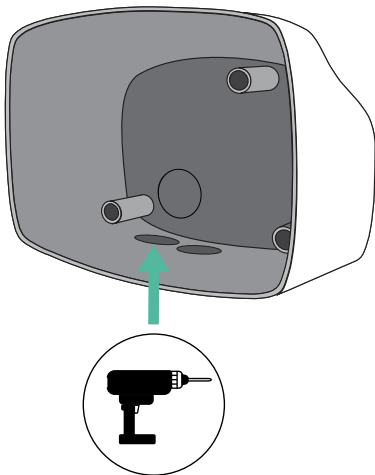

- 2.** Using a flat screwdriver, make an incision in the 3-exit grommet. Remember, that you need to use only one hole of the 3-exit grommet by each communication line.

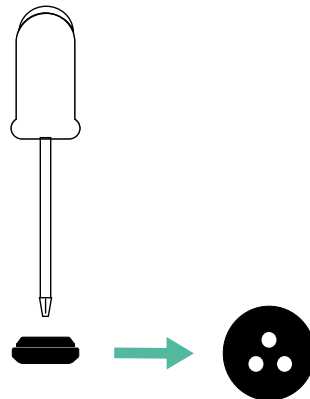

- 3.** Insert the **grommet** in the hole at the bottom of the charger.

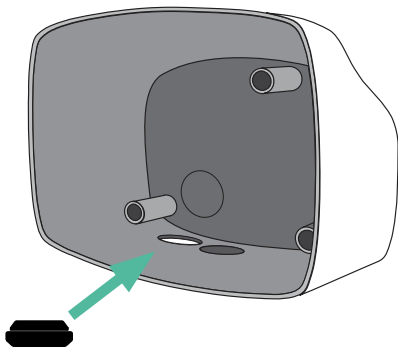

INSTALLATION WITH COMMANDER 2

Power Boost and Eco-Smart

Commander 2 Installation

Install the device following the instructions in the **Commander 2 Installation Guide**.



Important

Ensure not to close the cover of the charger.

Communication wiring between the charger and the meter

- 1.** Keep the power turned off during the installation.
- 2.** Insert the communication wire through the grommet.

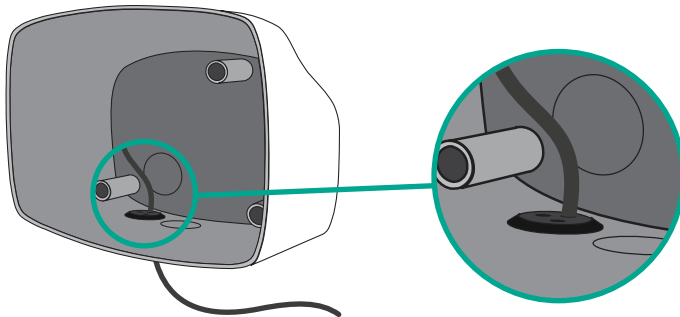

- 3.** Install the meter following the instructions in the Meter Wiring Guide included in the package.
- 4.** Wire the meter and the charger by following the relevant scheme below based on the model of your meter.



Important

It is mandatory to use an STP class 5E cable. Employ only 1 wire of each twisted pair and keep in mind that the communication wiring must not be more than 500m long.



Important

Insert only one cable for each grommet.

INSTALLATION WITH COMMANDER 2

Power Boost and Eco-Smart

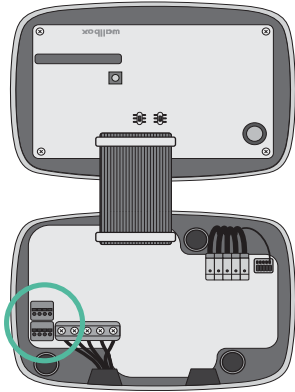

EM 112

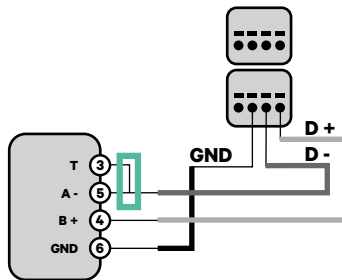

EM 340

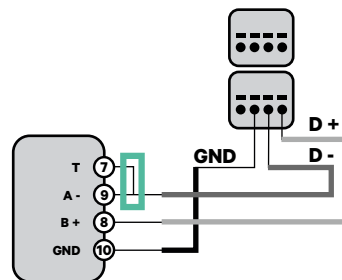

EM 330

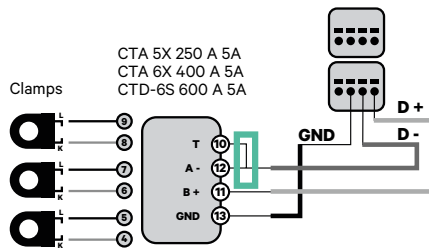
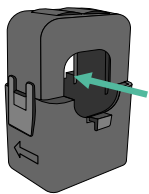

! For the EM330 configuration refer to the **Appendix**.

N1 CT

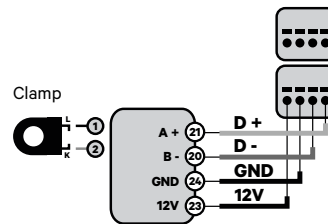

! For the N1CT installation, refer to the **Appendix**.

P1 Port

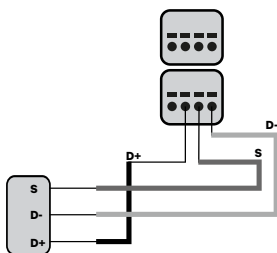

! For the P1 Port installation, refer to the **Appendix**.

SPM1-100-AC

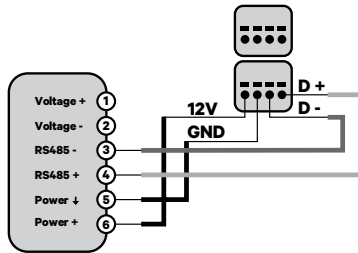

Pro MOD2

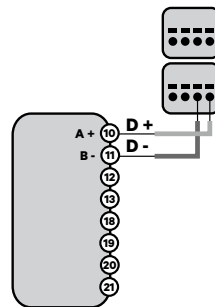

Pro 380 MOD

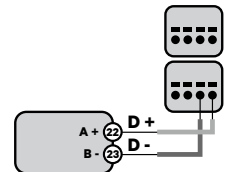

Important

Remember to check the Compatibility Table of each meter.

INSTALLATION WITH COMMANDER 2

Power Boost and Eco-Smart

Terminating resistance activation and current selector configuration

1. Put the RS485 switch into position T.
2. Put the rotary switch into a position between 1 and 7, depending on the maximum current that can be supplied from the charging network.

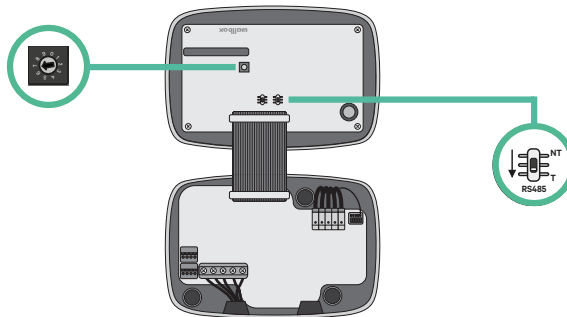

3. See the matrix below. This value must be equal or lower than the MCB protecting the Wallbox power line.

POSITION	0	1	2	3	4	5	6	7	8	9
CURRENT (A)	R	6	10	13	16	20	25	32	R	R

Note: Only Max Current > 6A per phase is accepted for a correct performance. In case of doubt, contact Wallbox Service.

4. Close the cover of the charger following the instructions in the **Installation Guide**.

INSTALLATION WITH COMMANDER 2

Power Sharing

Tools

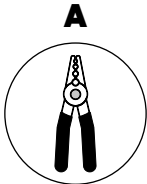

Wire Strippers

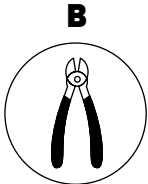

Cutting Pliers

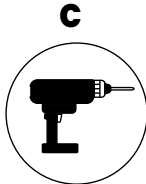

Drilling machine
M12 and hole saw
25mm

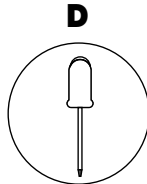

Flat Screwdriver

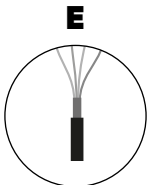

Connecting cable between
charger and charger
(UTP CAT 5E 250m
Max. Length)

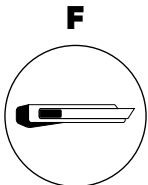

Cutter

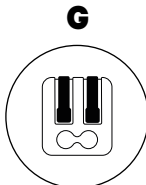

Two pole lever
connectors
(for small
communication
wires)

Refer to the **Commander 2 Installation Guide** to know more about the tools to install the charger.

INSTALLATION WITH COMMANDER 2

Power Sharing

Before Installation

- Ensure that the power is turned off during the installation.
- Separate the communication wires from the power ones.

Preparation

- 1.** Remove the plastic knock-out at the bottom of the charger using a 25mm drill bit hole saw drill.

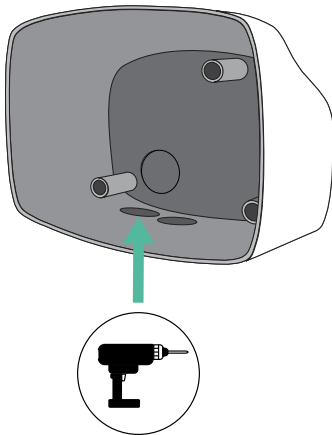

- 2.** Using a flat screwdriver, make an incision in the 3-exit grommet. Remember, that you need to use only one hole of the 3-exit grommet by each communication line.

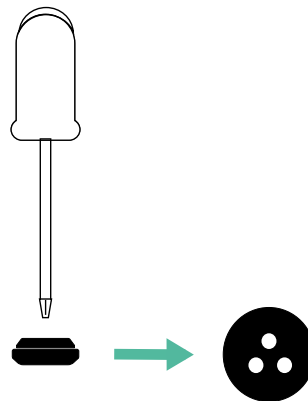

- 3.** Insert the **grommet** in the hole at the bottom of the charger.

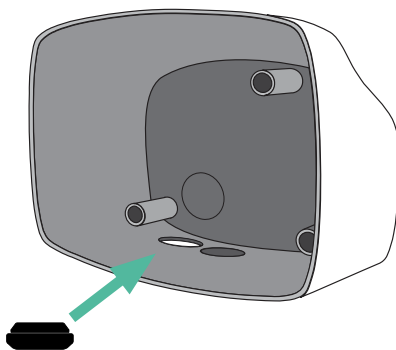

Commander 2 Installation

Install the charger following the instructions in the **Commander 2 Installation Guide**.



Important

Ensure not to close the cover of the charger.

INSTALLATION WITH COMMANDER 2

Power Sharing

Wiring the system

1. Ensure that the power is turned off during the installation.
2. Insert the communication wire (UTP 5E cable) through the grommet.

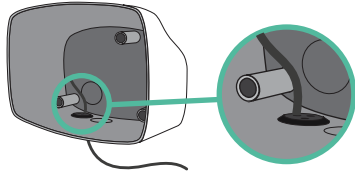

3. Check the position of CAN - L and CAN - H indicated above the connector. **Remember:** the sequence in the connector can be different depending on each product.
4. Once located the connector, start cabling the primary charger (the first of the chain). Use a UTP 5E cable (a pair), then, insert one of the cables in CAN-L and the other in CAN-H. After, connect the other chargers of the chain following the scheme below. As you may notice, all the chargers have CAN-L and a CAN-H inputs and outputs, except for the first and the last ones.

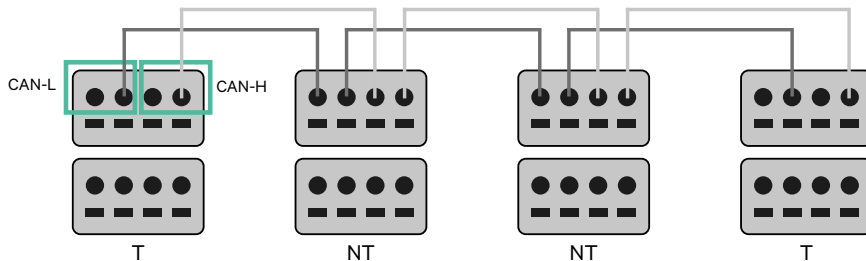

Important

- Make sure to connect each CAN-L to the respective CAN-L connector of all the chargers. Do the same for CAN-H.
- Power sharing works up to 25 chargers for each installation. Among them, one is primary and 24 are secondary. The maximum distance the communication wiring can reach is 250m.

	CAN-L	CAN-H
CAN-L	✓	×
CAN-H	×	✓

Note: Only Max Current > 6A per phase is accepted for a correct performance. In case of doubts, contact Wallbox Service.

Refer to the **Installation Guide** for more information.

INSTALLATION WITH COMMANDER 2

Power Sharing

Terminating settings

1. Once the cabling is completed, you need to activate the termination resistors. The first and the last charger will always be terminating (T) with non terminating (NT) chargers between them.

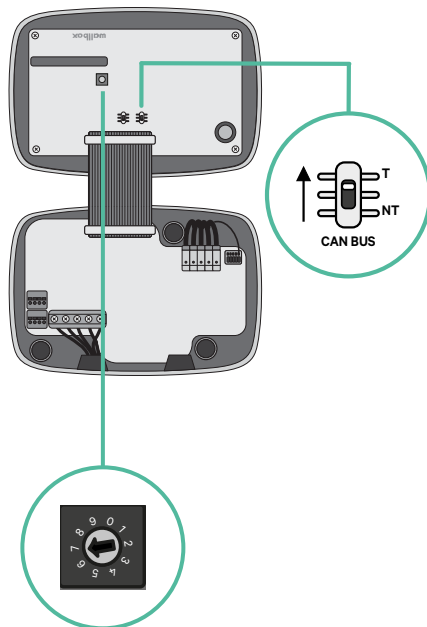
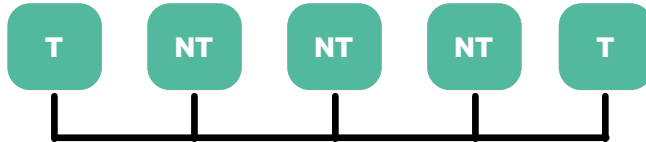

INSTALLATION WITH COMMANDER 2

Power Sharing

2. Once the termination resistors are set up, place the current selector of each charger following the information. The first charger of the chain is the primary charger, the others are secondary.

The **primary charger** will be set on position 8 or 9.

The **secondary chargers** will be set on position 0.

POSITION	0	1	2	3	4	5	6	7	8	9
MAX CURRENT	*PS	6	10	13	16	20	25	32	*PS	*PS

3. To ensure a proper set-up the measured **resistance between CAN-H and CAN-L must be near to 60 Ohms**. If it differs from that, recheck the proper wiring and the T/NT configuration.

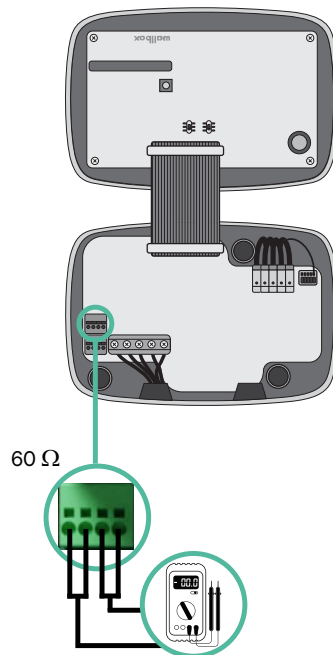

4. Close the cover of your charger by following the instructions in the respective **Installation Guide**.

INSTALLATION WITH COMMANDER 2

Power Sharing

Adding chargers in the future:

If you anticipate adding chargers to the system in the future, there are two ways you can prepare the system now to make it ready for Power Sharing.

Option 1: Place a bus disconnecter to accommodate future chargers as shown in the option 1 wiring scheme below. This option avoids the need of reopening the existing chargers and hence it is the recommended option.

Option 2: Truncate the existing bus to add new charger(s) as shown in the option 2 wiring scheme below.

1. Open the charger following the installation guide of your Commander 2 charger.
2. Set the terminating resistance into NT, make the communication wiring as explained above and then close the charger.



Important

New chargers may be placed anywhere physically in relation to the existing chargers as long as you follow these rules:

- You maintain the logic of the daisy chain.
- You respect the cabling polarity as described above under “Installation”.

Wherever a future added charger is placed, the most important rule to follow is the logic of the daisy chain. For example, in the image below, the new charger is placed before the Terminating charger on the right side of the daisy chain.

Option 1:

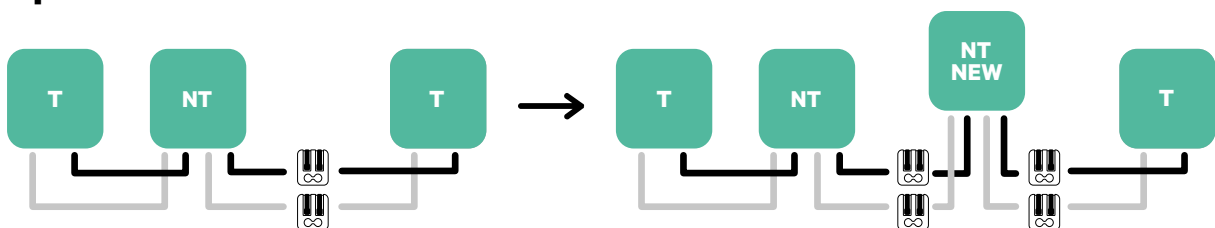

Option 2:

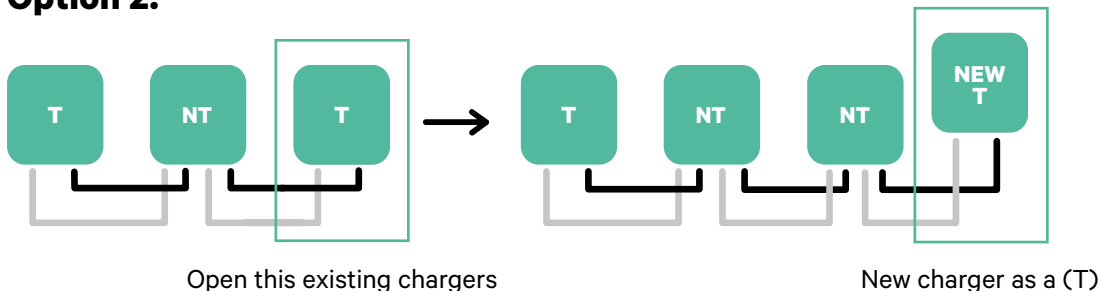

INSTALLATION WITH COMMANDER 2

Dynamic Power Sharing

Tools

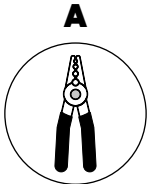

Wire Strippers

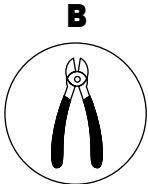

Cutting Pliers

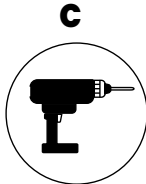

Drilling machine
M12 and hole saw
25mm

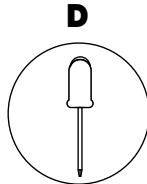

Flat Screwdriver

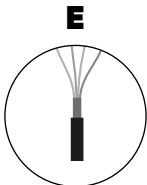

Connecting cable between
charger and meter
(STP Class 5E
500m Max Length)

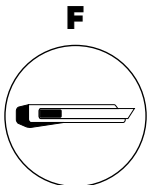

Cutter

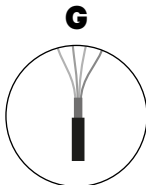

Connecting cable between
charger and charger
(UTP CAT 5E
250m Max Length)

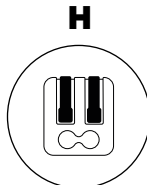

Two pole lever
connectors
(for small
communication
wires)

Refer to the **Commander 2 Installation Guide** to know more about the tools to install the charger.

INSTALLATION WITH COMMANDER 2

Dynamic Power Sharing

Before Installation

- Ensure that the power is turned off during the installation.
- Separate the communication wires from the power ones.

Preparation

- 1.** Remove the plastic knock-out at the bottom of the charger using a 25mm drill bit hole saw.

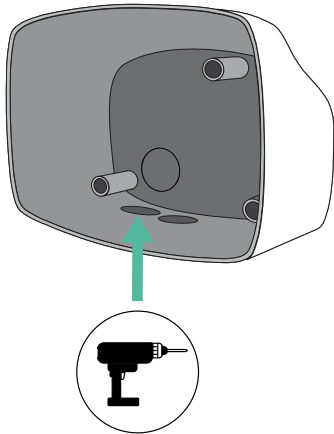

- 2.** Using a flat screwdriver, make an incision in the 3-exit grommet. Remember, that you need to use only one hole of the 3-exit grommet by each communication line.

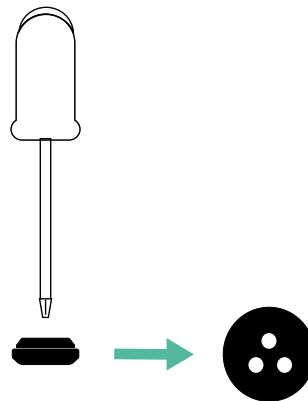

- 3.** Insert the **grommet** in the bottom hole of the charger.

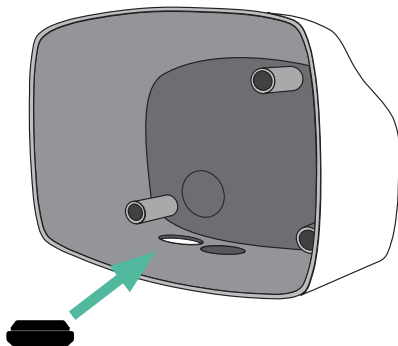

INSTALLATION WITH COMMANDER 2

Dynamic Power Sharing

Commander 2 Installation

Install the device following the instructions in the [Commander 2 Installation Guide](#).



Important

Ensure not to close the cover of the charger.

Communication wiring between the charger and the meter

- 1.** Keep the power turned off during the installation.
- 2.** Insert through the grommet the two communication wires, one for meter communication and the other one for communication between chargers.

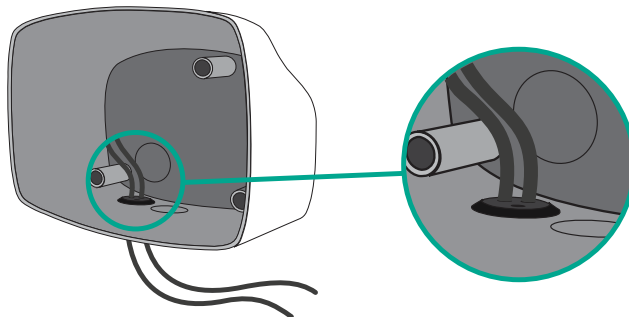

- 3.** Install the meter following the instructions in the Meter Wiring Guide included in the package.
- 4.** Wire the meter and the charger by following the relevant scheme below based on the model of your meter.



Important

It is mandatory to use an STP class 5E cable. Employ only 1 wire of each twisted pair and keep in mind that the communication wiring must not be more than 500m long.



Important

Insert only one cable for each grommet.

INSTALLATION WITH COMMANDER 2

Dynamic Power Sharing

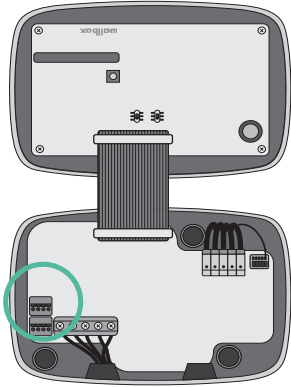

EM 112

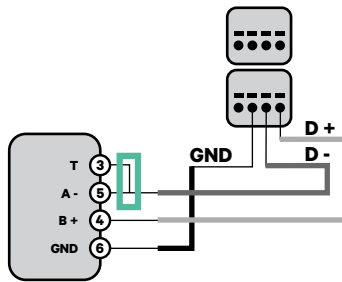

EM 340

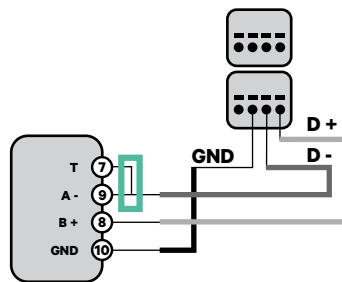

EM 330

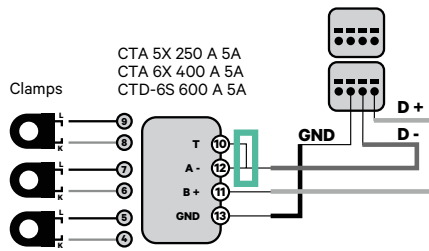
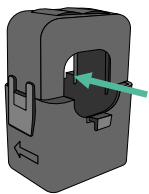

N1 CT

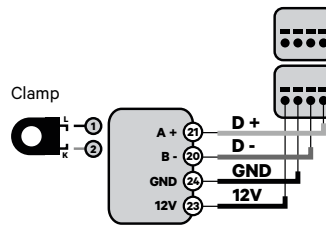

! For the EM330 configuration refer to the **Appendix**.

! For the N1CT installation, refer to the **Appendix**.

P1 Port

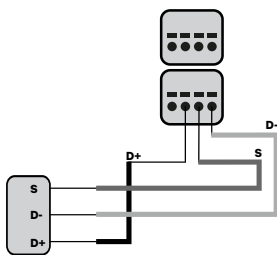

! For the P1 Port installation, refer to the **Appendix**.

SPM1-100-AC

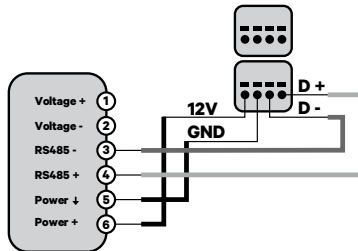

Pro MOD2

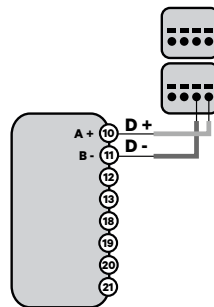

Pro 380 MOD

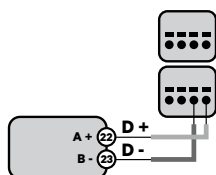

INSTALLATION WITH COMMANDER 2

Dynamic Power Sharing

Wiring the system

1. Ensure that the power is turned off during the installation.
2. Check the position of CAN - L and CAN - H indicated above the connector.
Remember: the sequence in the connector can be different depending on each product.
3. Once located the connector, start cabling the primary charger (the first of the chain). Use a UTP 5E cable (a pair), then, insert one of the cables in CAN-L and the other in CAN-H. After, connect the other chargers of the chain following the scheme below. As you may notice, all the chargers have CAN-L and a CAN-H inputs and outputs, except for the first and the last ones.

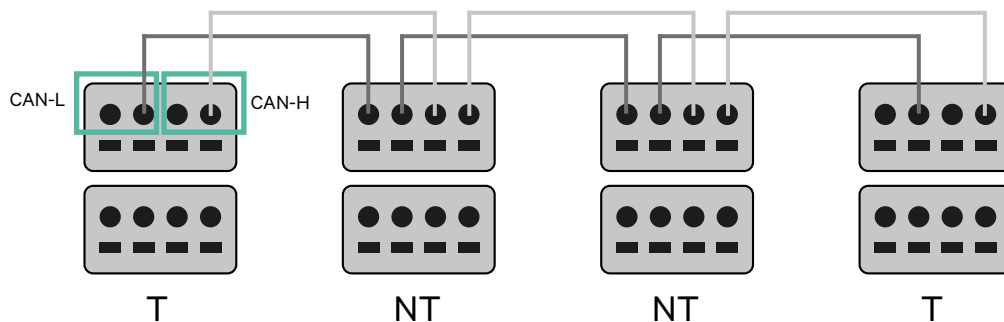

Important

- Make sure to connect each CAN-L to the respective CAN-L connector of all the chargers. Do the same for CAN-H.
- Power sharing works up to 25 chargers for each installation. Among them, one is primary and 24 are secondary. The maximum distance the communication wiring can reach is 250m.

	CAN-L	CAN-H
CAN-L	✓	×
CAN-H	×	✓

Note: Only Max Current > 6A per phase is accepted for a correct performance. In case of doubts, contact Wallbox Service.

INSTALLATION WITH COMMANDER 2

Dynamic Power Sharing

Terminating settings

1. Once the cabling is complete, you need to activate the terminating resistors. First set up RS485 into T only for the charger that is connected into meter. Then set up the CAN BUS, the first and the last charger will always be terminating (T) with non terminating (NT) chargers between them.

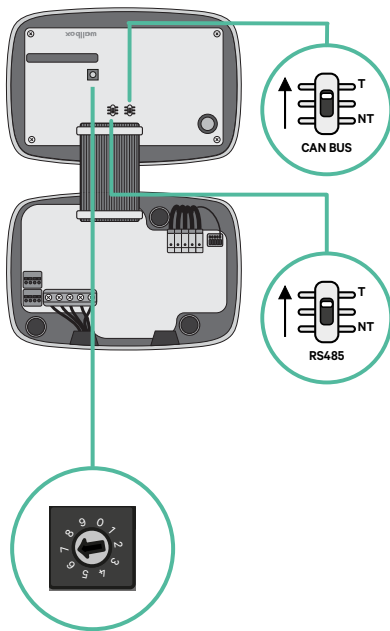
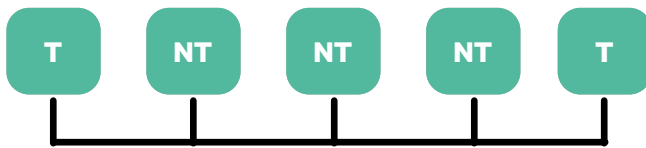

INSTALLATION WITH COMMANDER 2

Dynamic Power Sharing

2. Once the termination resistors are set up, place the current selector of each charger following the information. The first charger of the chain is the primary charger, the others are secondary.

The **primary charger** will be set on position 8 or 9.

The **secondary chargers** will be set on position 0.

POSITION	0	1	2	3	4	5	6	7	8	9
MAX CURRENT	*PS	6	10	13	16	20	25	32	*PS	*PS

3. To ensure a proper set-up the measured **resistance between CAN-H and CAN-L must be near to 60 Ohms**. If it differs from that, recheck the proper wiring and the T/NT configuration.

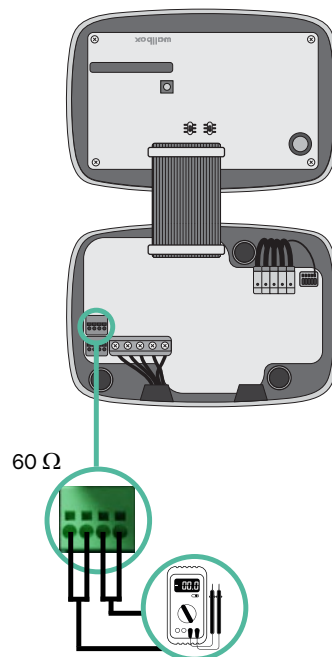

4. Close the cover of your charger by following the instructions in the respective **Installation Guide**.

INSTALLATION WITH COMMANDER 2

Dynamic Power Sharing

Adding chargers in the future:

If you anticipate adding chargers to the system in the future, there are two ways you can prepare the system now to make it ready for Dynamic Power Sharing.

Option 1: Place a bus disconnecter to accommodate future chargers as shown in the option 1 wiring scheme below. This option avoids the need of reopening the existing chargers and hence it is the recommended option.

Option 2: Truncate the existing bus to add new charger(s) as shown in the option 2 wiring scheme below.

1. Open the charger following the installation guide of your Commander 2 charger.
2. Set the terminating resistance into NT, make the communication wiring as explained above and then close the charger.



Important

New chargers may be placed anywhere physically in relation to the existing chargers as long as you follow these rules:

- You maintain the logic of the daisy chain.
- You respect the cabling polarity as described above under “Installation”.

Wherever a future added charger is placed, the most important rule to follow is the logic of the daisy chain. For example, in the image below, the new charger is placed before the Terminating charger on the right side of the daisy chain.

Option 1:

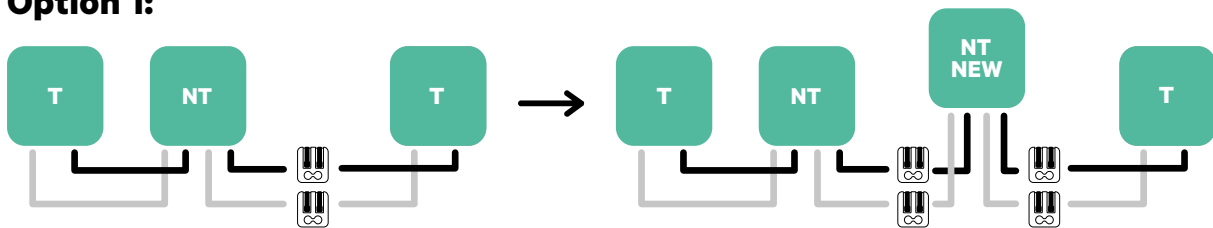

Option 2:

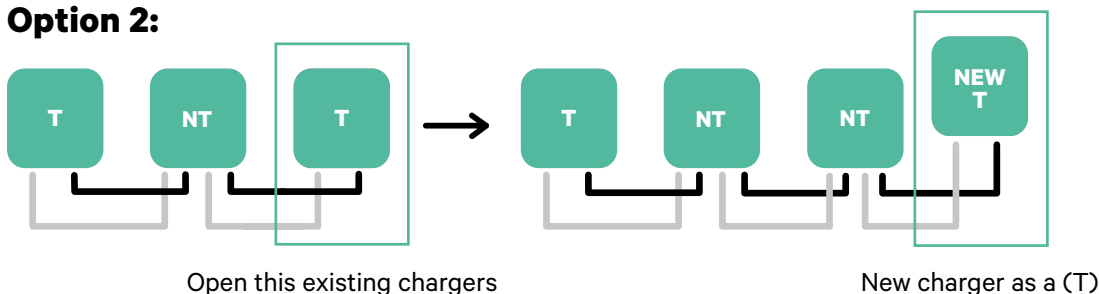

Once you finish the extension of the existing installation, continue with steps on the next page for setting up the chargers.

! To install Dynamic Power Sharing with four chargers, check the **Appendix**.

INSTALLATION WITH COPPER SB
Power Boost and Eco-Smart

Tools

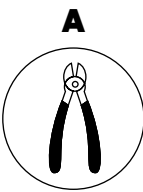

Cutting Pliers

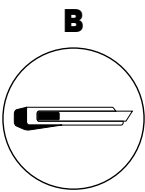

Utility Knife

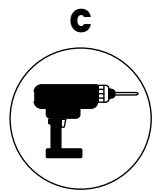

Drilling machine
M12 and hole saw
25mm

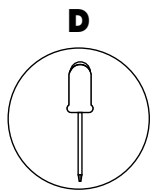

Flat Screwdriver
6mm

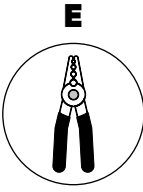

Wire
Strippers

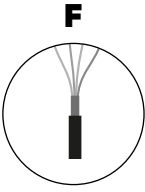

Connecting cable between
charger and meter
(STP Class 5E
500m Max Length)

Refer to the **Copper SB Installation Guide** to know more about the tools to install the charger.

INSTALLATION WITH COPPER SB

Power Boost and Eco-Smart

Place the energy meter after the mains supply and before the fuse box.

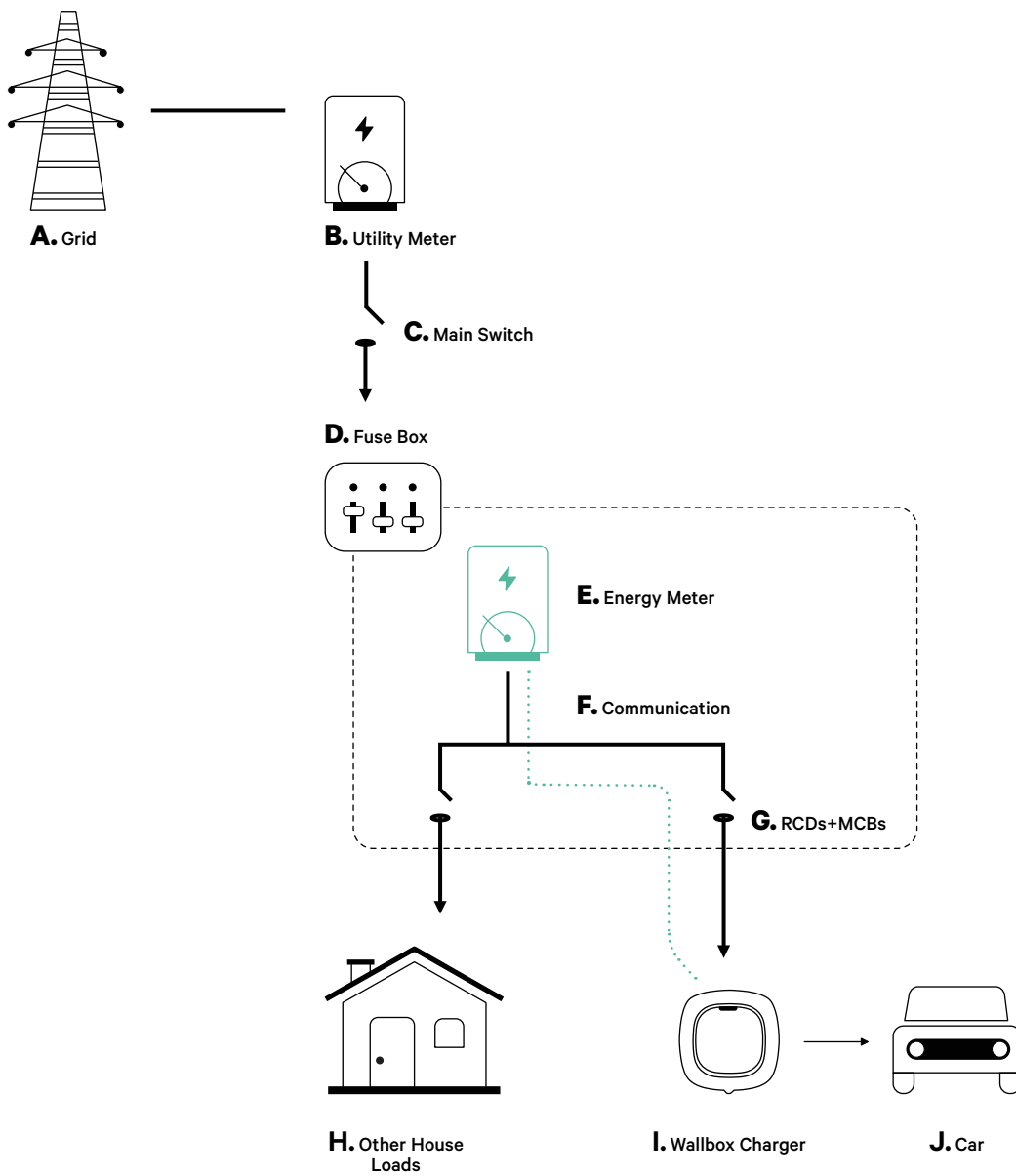

INSTALLATION WITH COPPER SB

Power Boost and Eco-Smart

Before Installation

- Ensure that the power is turned off during the installation.
- Separate the communication wires from the power ones.

Preparation

- 1.** Remove the plastic knock-out at the bottom of the charger using an M12 drill bit.

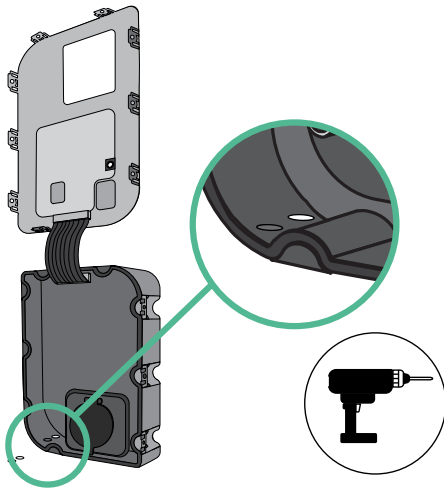

- 2.** Make a hole in the grommet using a flat screw driver.

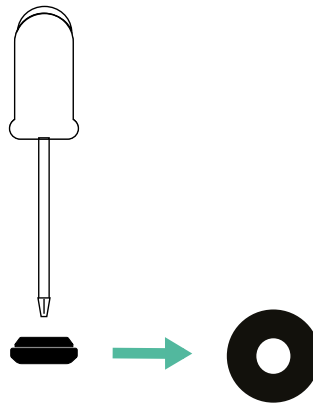

- 3.** Insert the **grommet** in the hole at the bottom of the charger.

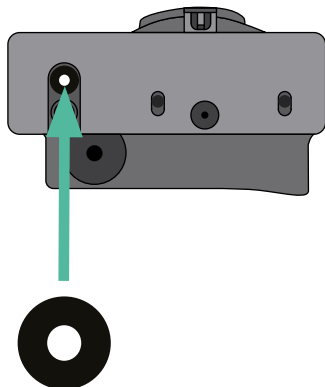

INSTALLATION WITH COPPER SB

Power Boost and Eco-Smart

Copper SB Installation

Install the device following the instructions in the [Copper SB Installation Guide](#).



Important

Ensure not to close the cover of the charger.

Communication wiring between the charger and the meter

- 1.** Keep the power turned off during the installation.
- 2.** Insert the communication wire through the grommet.

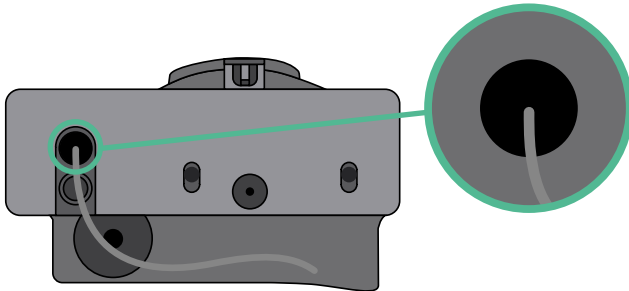

- 3.** Install the meter following the instructions in the Meter Wiring Guide included in the package.
- 4.** Wire the meter and the charger by following the relevant scheme below based on the model of your meter.



Important

It is mandatory to use an STP class 5E cable. Employ only 1 wire of each twisted pair and keep in mind that the communication wiring must not be more than 500m long.



Important

Insert only one cable for each grommet.

INSTALLATION WITH COPPER SB

Power Boost and Eco-Smart

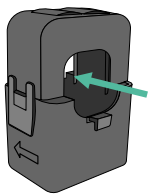
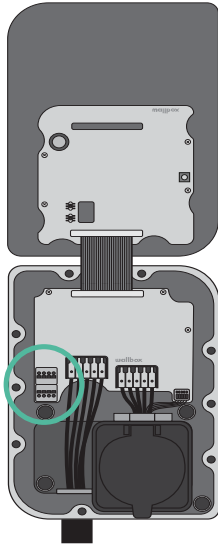

EM 112

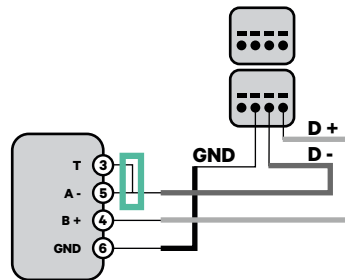

EM 340

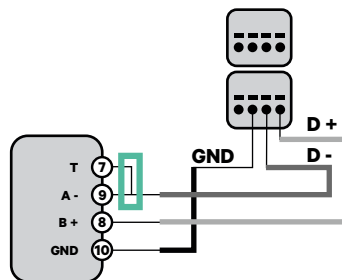

EM 330

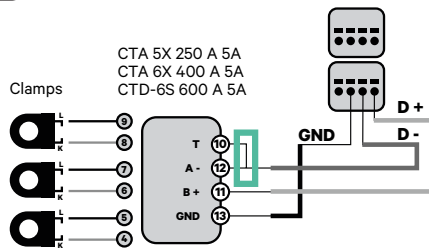

N1 CT

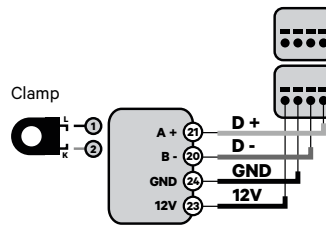

! For the EM330 configuration refer to the **Appendix**.

! For the N1CT installation, refer to the **Appendix**.

P1 Port

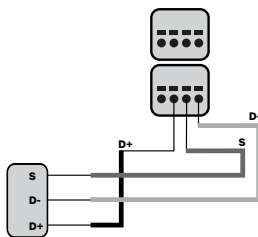

! For the P1 Port installation, refer to the **Appendix**.

SPM1-100-AC

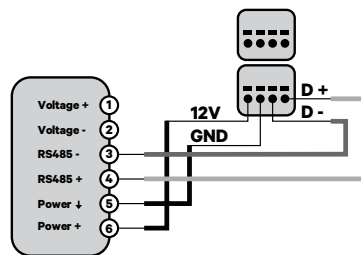

Pro MOD2

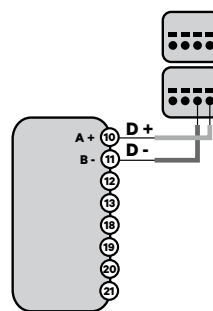

Pro 380 MOD

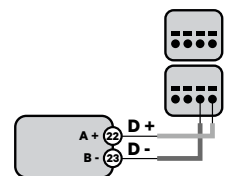

Important

Remember to check the Compatibility Table of each meter.

INSTALLATION WITH COPPER SB

Power Boost and Eco-Smart

Terminating resistance activation and current selector configuration

1. Put the RS485 switch into position T.
2. Put the rotary switch into a position between 1 and 7, depending on the maximum current that can be supplied from the charging network.

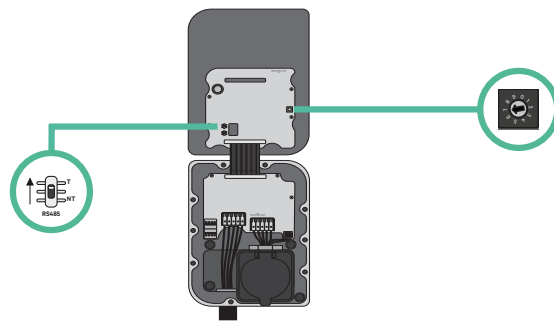

3. See the matrix below. This value must be equal or lower than the MCB protecting the Wallbox power line.

POSITION	0	1	2	3	4	5	6	7	8	9
CURRENT (A)	R	6	10	13	16	20	25	32	R	R

Note: Only Max Current > 6A per phase is accepted for a correct performance. In case of doubts, contact Wallbox Service.

4. Close the cover of the charger following the instructions in the **Installation Guide**.

INSTALLATION WITH COPPER SB

Power Sharing

Tools

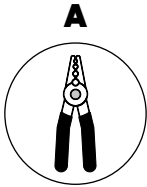

Wire Strippers

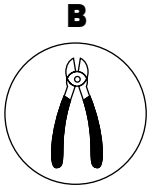

Cutting Pliers

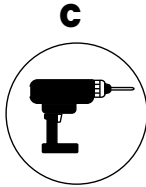

Drilling machine
M12 and hole saw
25mm

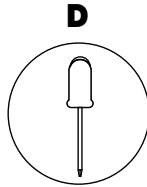

Flat Screwdriver

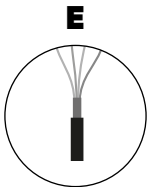

Connecting cable between
charger and charger
(UTP CAT 5E 250m
Max. Length)

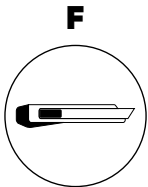

Cutter

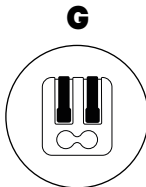

Two pole lever
connectors
(for small
communication
wires)

Refer to the **Copper SB Installation Guide** to know more about the tools to install the charger.

INSTALLATION WITH COPPER SB

Power Sharing

Before Installation

- Ensure that the power is turned off during the installation.
- Separate the communication wires from the power ones.

Preparation

- 1.** Open the cover of the charger by following the instructions in **Copper SB Installation Guide**.

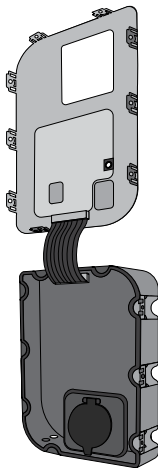

- 2.** Remove the plastic knock-out at the bottom of the charger using an M12 drill bit.

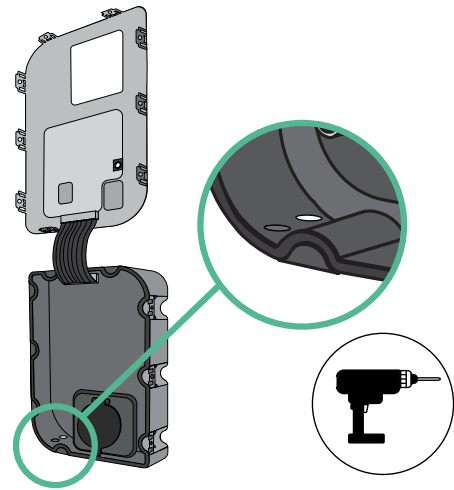

- 3.** Make a hole in the grommet using a flat screw driver.

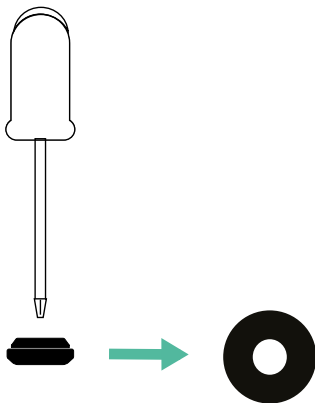

- 4.** Insert the **grommet** in the hole at the bottom of the charger.

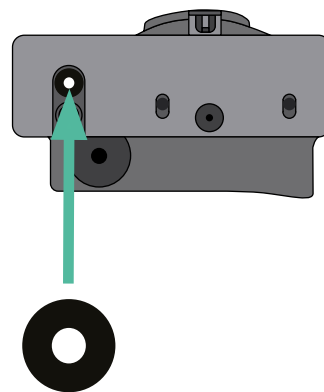

Copper SB Installation

Install the charger following the instructions in the **Copper SB Installation Guide**.



Important

Ensure not to close the cover of the charger.

INSTALLATION WITH COPPER SB

Power Sharing

Wiring the system

1. Ensure that the power is turned off during the installation.
2. Insert the communication wire (UTP 5E cable) through the grommet.

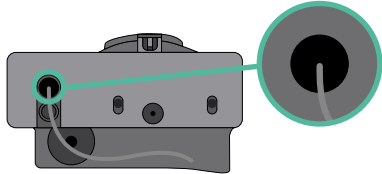

3. Check the position of CAN - L and CAN - H indicated above the connector.
Remember: the sequence in the connector can be different depending on each product.
4. Once located the connector, start cabling the primary charger (the first of the chain). Use a UTP 5E cable (a pair), then, insert one of the cables in CAN-L and the other in CAN-H. After, connect the other chargers of the chain following the scheme below. As you may notice, all the chargers have CAN-L and a CAN-H inputs and outputs, except for the first and the last ones.

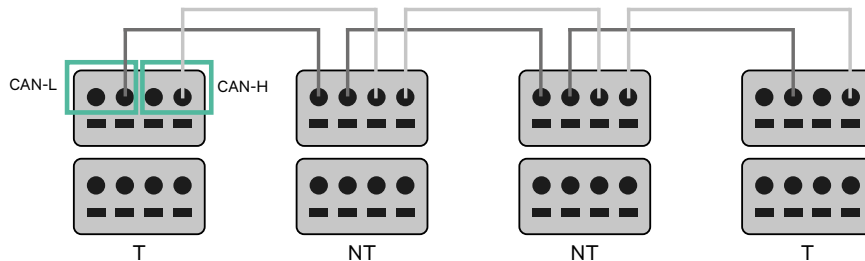

Important

- Make sure to connect each CAN-L to the respective CAN-L connector of all the chargers. Do the same for CAN-H.
- Power sharing works up to 25 chargers for each installation. Among them, one is primary and 24 are secondary. The maximum distance the communication wiring can reach is 250m.

	CAN-L	CAN-H
CAN-L	✓	×
CAN-H	×	✓

Note: Only Max Current > 6A per phase is accepted for a correct performance. In case of doubts, contact Wallbox Service.

INSTALLATION WITH COPPER SB
Wiring the System

Terminating settings

- 1.** Once the cabling is completed, you need to activate the termination resistors. The first and the last charger will always be terminating (T) with non terminating (NT) chargers between them.

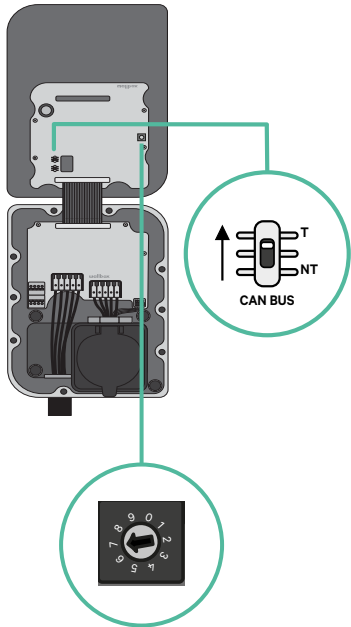
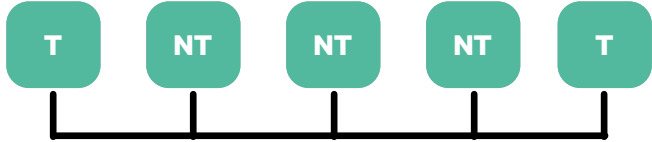

INSTALLATION WITH COPPER SB

Wiring the System

2. Once the termination resistors are set up, place the current selector of each charger following the information. The first charger of the chain is the primary charger, the others are secondary.

The **primary charger** will be set on position 8 or 9.

The **secondary chargers** will be set on position 0.

POSITION	0	1	2	3	4	5	6	7	8	9
MAX CURRENT	*PS	6	10	13	16	20	25	32	*PS	*PS

3. To ensure a proper set-up the measured **resistance between CAN-H and CAN-L must be near to 60 Ohms**. If it differs from that, recheck the proper wiring and the T/NT configuration.

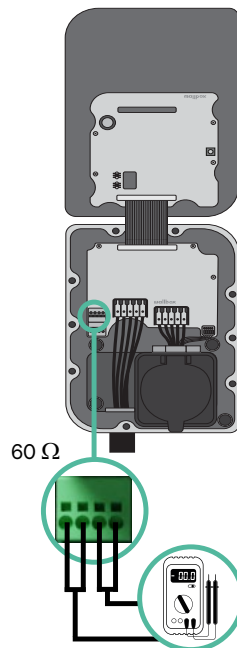

4. Close the cover of the charger following the instructions in the respective **Installation Guide**.

INSTALLATION WITH COPPER SB

Power Sharing

Adding chargers in the future:

If you anticipate adding chargers to the system in the future, there are two ways you can prepare the system now to make it ready for Power Sharing.

Option 1: Place a bus disconnecter to accommodate future chargers as shown in the option 1 wiring scheme below. This option avoids the need of reopening the existing chargers and hence it is the recommended option.

Option 2: Truncate the existing bus to add new charger(s) as shown in the option 2 wiring scheme below.

1. Open the charger following the installation guide of your Copper SB charger.
2. Set the terminating resistance into NT, make the communication wiring as explained above and then close the charger.



Important

New chargers may be placed anywhere physically in relation to the existing chargers as long as you follow these rules:

- You maintain the logic of the daisy chain.
- You respect the cabling polarity as described above under “Installation”.

Wherever a future added charger is placed, the most important rule to follow is the logic of the daisy chain. For example, in the image below, the new charger is placed before the Terminating charger on the right side of the daisy chain.

Option 1:

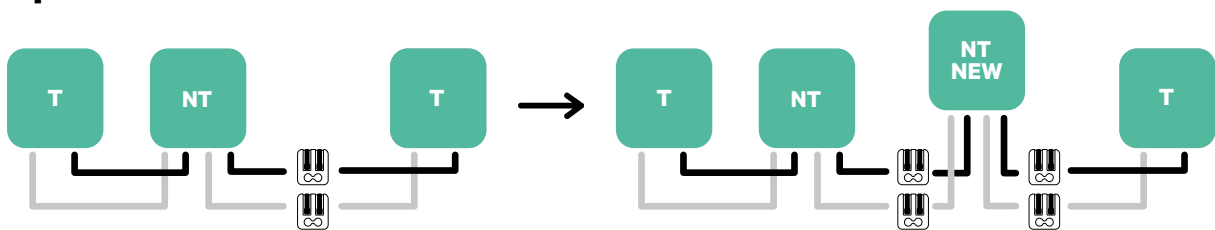

Option 2:

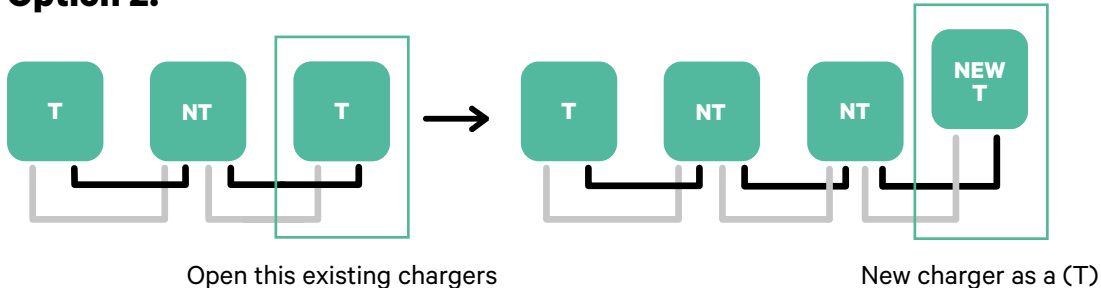

INSTALLATION WITH COPPER SB

Dynamic Power Sharing

Tools

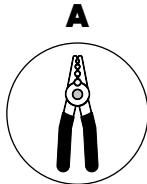

Wire Strippers

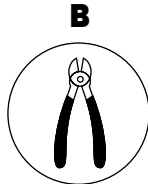

Cutting Pliers

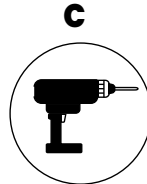

Drilling machine
M12 and hole saw
25mm

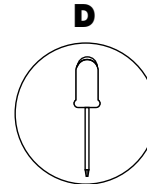

Flat Screwdriver

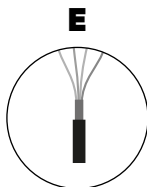

Connecting cable between
charger and meter
(STP Class 5E
500m Max Length)

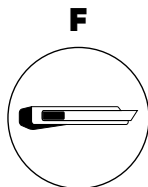

Cutter

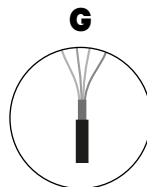

Connecting cable between
charger and charger
(UTP CAT 5E 250m
Max. Length)

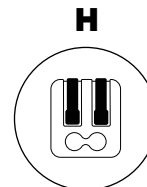

Two pole lever
connectors
(for small
communication
wires)

Refer to the **Copper SB Installation Guide** to know more about the tools to install the charger.

INSTALLATION WITH COPPER SB

Dynamic Power Sharing

Before Installation

- Ensure that the power is turned off during the installation.
- Separate the communication wires from the power ones.

Preparation

- 1.** Open the cover of the charger by following the instructions in **Copper SB Installation Guide**.

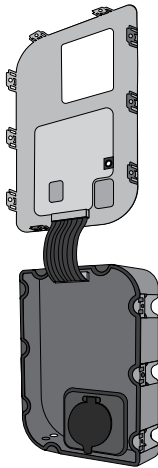

- 2.** Remove the plastic knock-out at the bottom of the charger using an M12 drill bit.

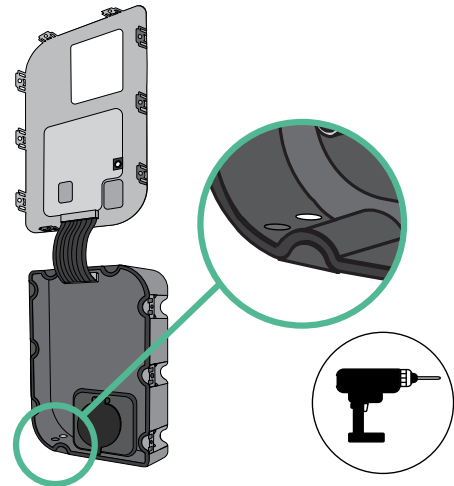

- 3.** Make a hole in the grommet using a flat screw driver.

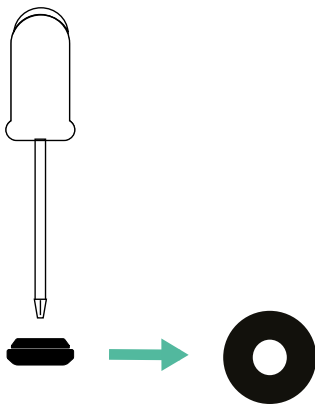

- 4.** Insert the **grommet** in the hole at the bottom of the charger.

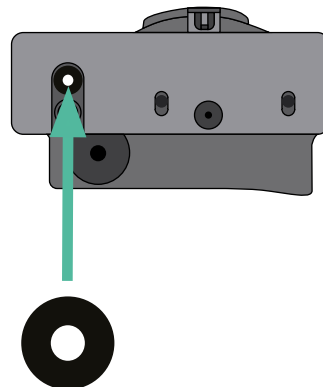

INSTALLATION WITH COPPER SB

Dynamic Power Sharing

Copper SB Installation

Install the device following the instructions in the [Copper SB Installation Guide](#).



Important

Ensure not to close the cover of the charger.

Communication wiring between the charger and the meter

- 1.** Keep the power turned off during the installation.
- 2.** Insert through the grommet the two communication wires, one for meter communication and the other one for communication between chargers.

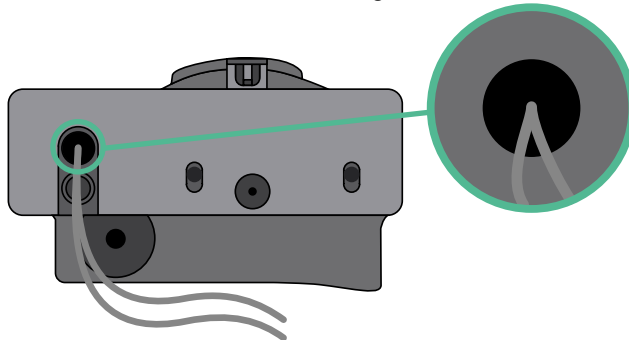

- 3.** Install the meter following the instructions in the Meter Wiring Guide included in the package.
- 4.** Wire the meter and the charger by following the relevant scheme below based on the model of your meter.



Important

It is mandatory to use an STP class 5E cable. Employ only 1 wire of each twisted pair and keep in mind that the communication wiring must not be more than 500m long.

INSTALLATION WITH COPPER SB

Dynamic Power Sharing

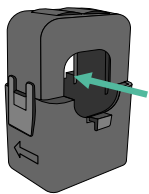
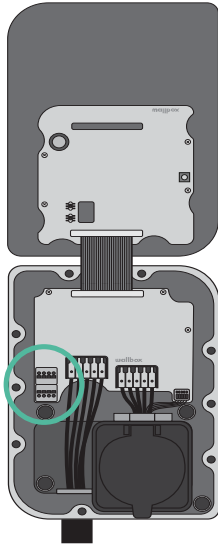

EM 112

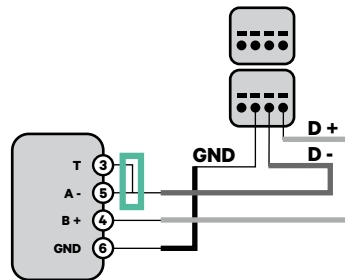

EM 340

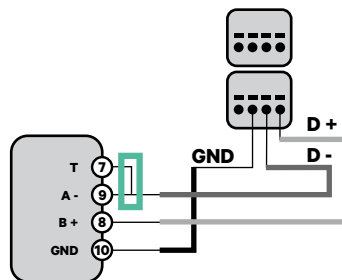

EM 330

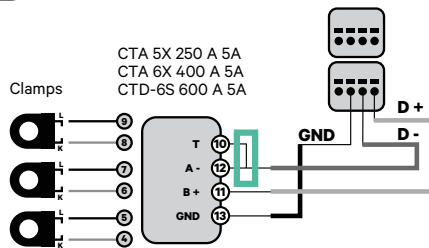

! For the EM330 configuration refer to the **Appendix**.

N1 CT

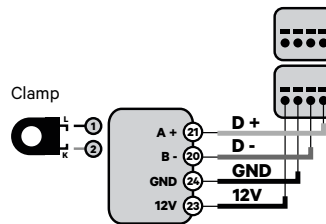

! For the N1CT installation, refer to the **Appendix**.

P1 Port

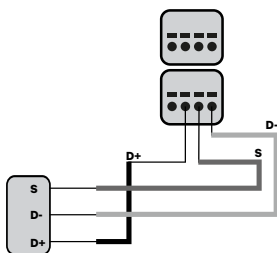

! For the P1 Port installation, refer to the **Appendix**.

SPM1-100-AC

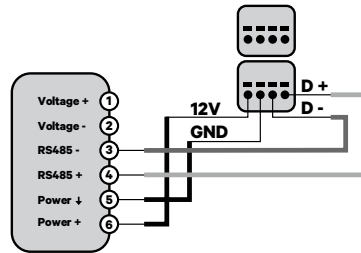

Pro MOD2

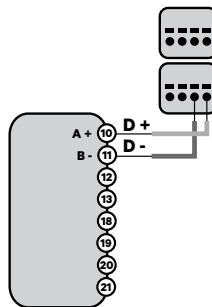

Pro 380 MOD

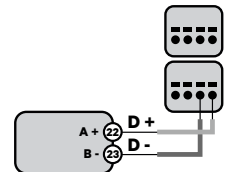

Important

Remember to check the Compatibility Table of each meter.

INSTALLATION WITH COPPER SB

Dynamic Power Sharing

Wiring the system

1. Ensure that the power is turned off during the installation.
2. Check the position of CAN - L and CAN - H indicated above the connector.
Remember: the sequence in the connector can be different depending on each product.
3. Once located the connector, start cabling the primary charger (the first of the chain). Use a UTP 5E cable (a pair), then, insert one of the cables in CAN-L and the other in CAN-H. After, connect the other chargers of the chain following the scheme below. As you may notice, all the chargers have CAN-L and a CAN-H inputs and outputs, except for the first and the last ones.

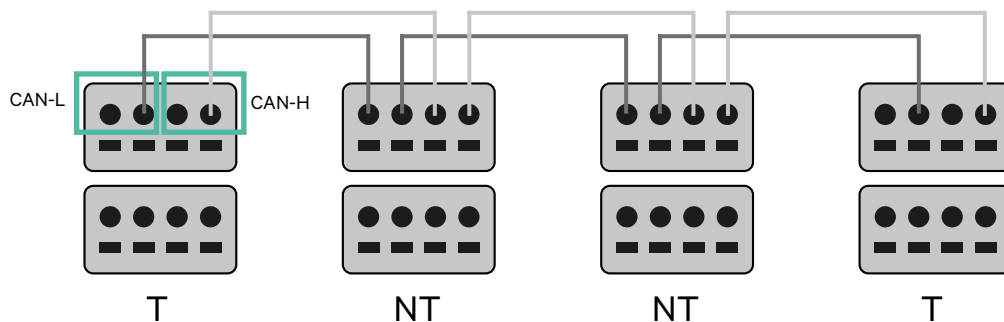

Important

- Make sure to connect each CAN-L to the respective CAN-L connector of all the chargers. Do the same for CAN-H.
- Power sharing works up to 25 chargers for each installation. Among them, one is primary and 24 are secondary. The maximum distance the communication wiring can reach is 250m.

	CAN-L	CAN-H
CAN-L	✓	×
CAN-H	×	✓

Note: Only Max Current > 6A per phase is accepted for a correct performance. In case of doubts, contact Wallbox Service.

INSTALLATION WITH COPPER SB
Dynamic Power Sharing

Terminating settings

- 1.** Once the cabling is complete, you need to activate the terminating resistors. First set up RS485 into T only for the charger that is connected into meter. Then set up the CAN BUS, the first and the last charger will always be terminating (T) with non terminating (NT) chargers between them.

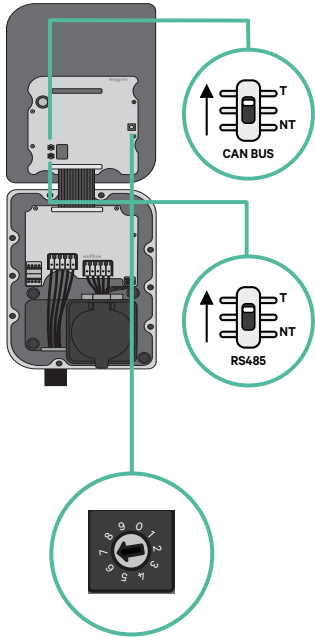
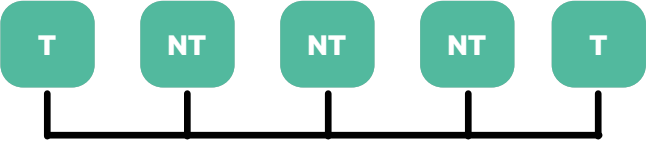

INSTALLATION WITH COPPER SB

Dynamic Power Sharing

2. Once the termination resistors are set up, place the current selector of each charger following the information. The first charger of the chain is the primary charger, the others are secondary.

The **primary charger** will be set on position 8 or 9.

The **secondary chargers** will be set on position 0.

POSITION	0	1	2	3	4	5	6	7	8	9
MAX CURRENT	*PS	6	10	13	16	20	25	32	*PS	*PS

3. To ensure a proper set-up the measured **resistance between CAN-H and CAN-L must be near to 60 Ohms**. If it differs from that, recheck the proper wiring and the T/NT configuration.

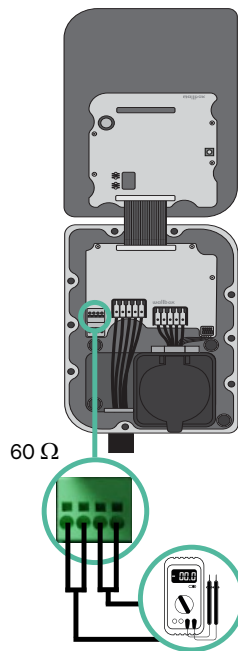

4. Close the cover of the charger following the instructions in the respective **Installation Guide**.

INSTALLATION WITH COMMANDER 2

Dynamic Power Sharing

Adding chargers in the future:

If you anticipate adding chargers to the system in the future, there are two ways you can prepare the system now to make it ready for Dynamic Power Sharing.

Option 1: Place a bus disconnecter to accommodate future chargers as shown in the option 1 wiring scheme below. This option avoids the need of reopening the existing chargers and hence it is the recommended option.

Option 2: Truncate the existing bus to add new charger(s) as shown in the option 2 wiring scheme below.

1. Open the charger following the installation guide of your Copper SB charger.
2. Set the terminating resistance into NT, make the communication wiring as explained above and then close the charger.



Important

New chargers may be placed anywhere physically in relation to the existing chargers as long as you follow these rules:

- You maintain the logic of the daisy chain.
- You respect the cabling polarity as described above under “Installation”.

Wherever a future added charger is placed, the most important rule to follow is the logic of the daisy chain. For example, in the image below, the new charger is placed before the Terminating charger on the right side of the daisy chain.

Option 1:

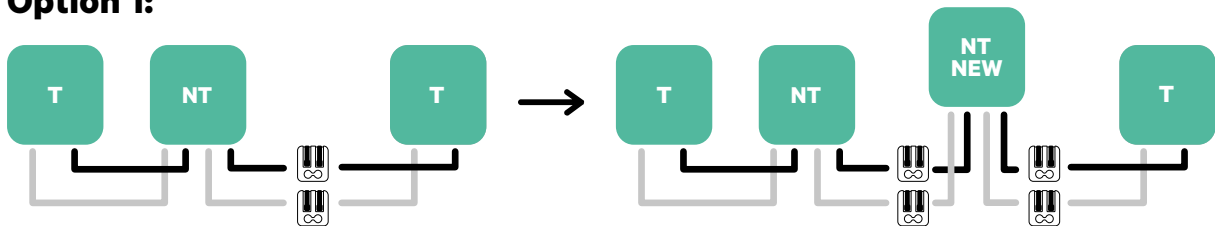

Option 2:

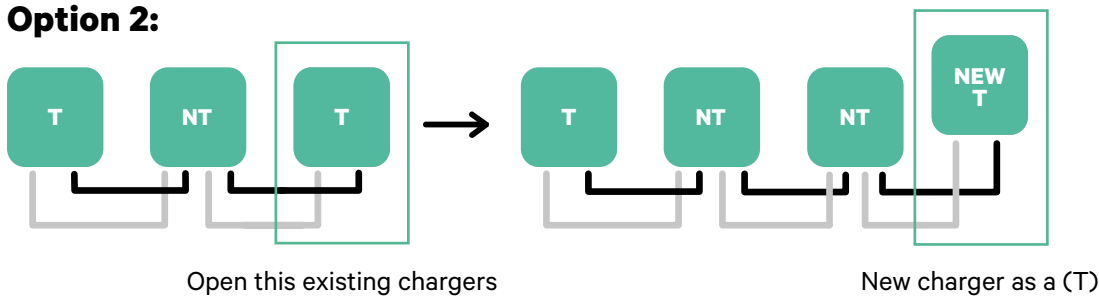

Once you finish the extension of the existing installation, continue with steps on the next page for setting up the chargers.

! To install Dynamic Power Sharing with four chargers, check the **Appendix**.

INSTALLATION WITH QUASAR V2H

Tools

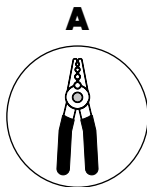

Wire Strippers

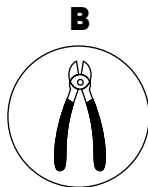

Cutting Pliers

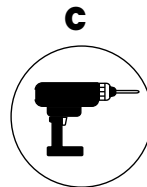

Drilling machine
hole saw 25mm.

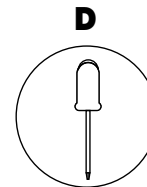

Flat Screwdriver
6mm

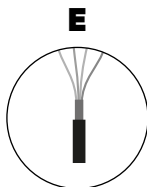

Connecting cable between
charger and meter
(STP Class 5E
500m Max Length)

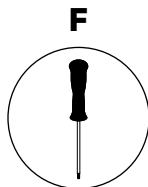

Torx T10

Refer to the **Quasar Installation Guide** to know more about the tools to install the charger.

INSTALLATION WITH QUASAR V2H

Place the energy meter after the mains supply and before the fuse box.

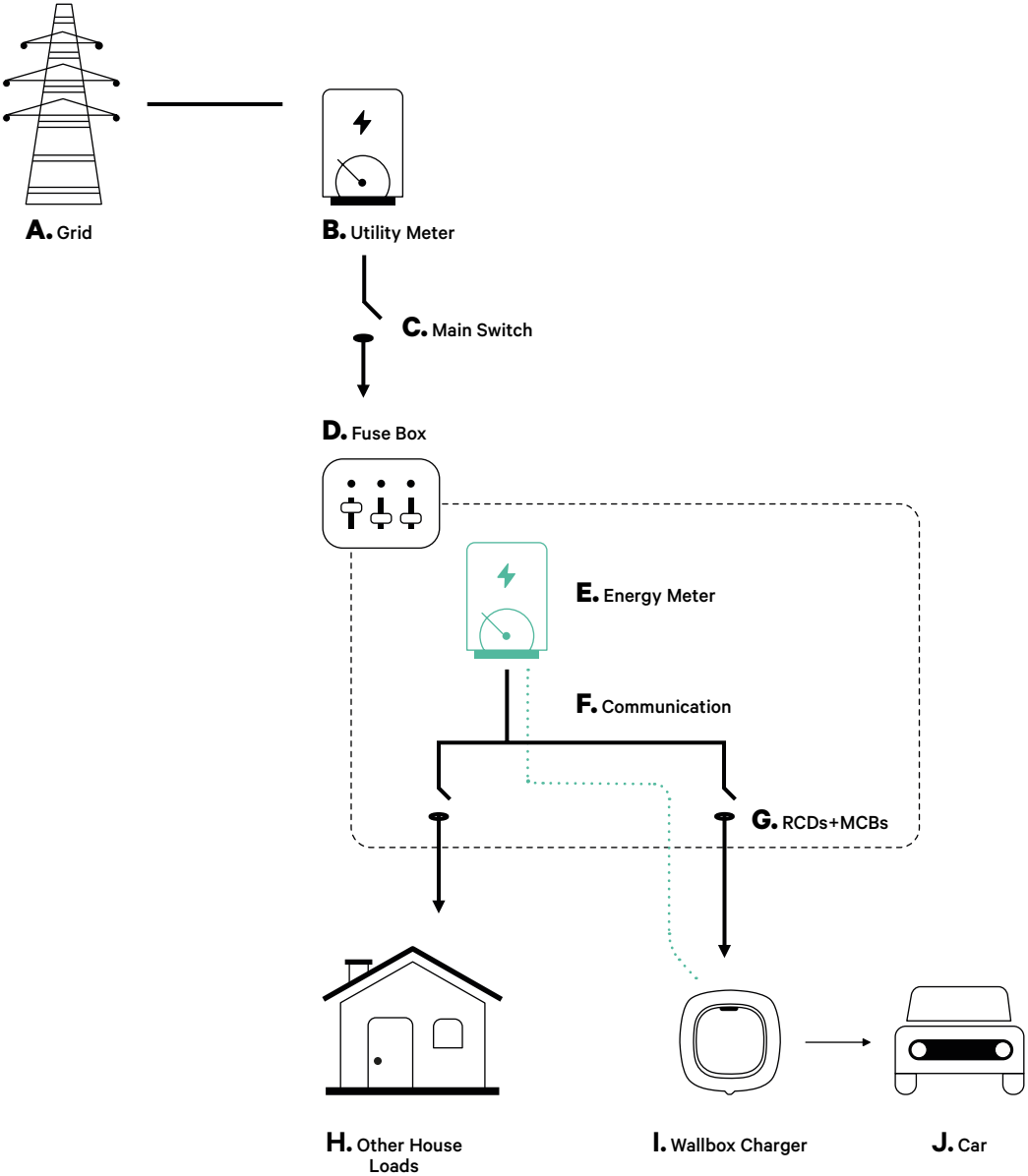

INSTALLATION WITH QUASAR V2H

Preparation

Keep the power turned off during the installation. Install the device following the instructions in the **Quasar Installation Guide**.

Installation

1. Remove the screws to open the communication lid.

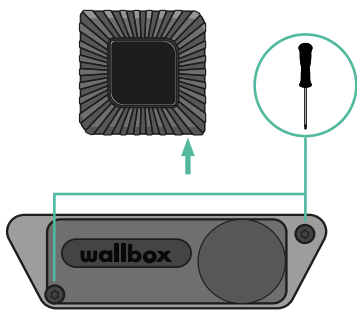

2. Remove the knock-out at the bottom of the charger using a 25mm hole saw drill bit.

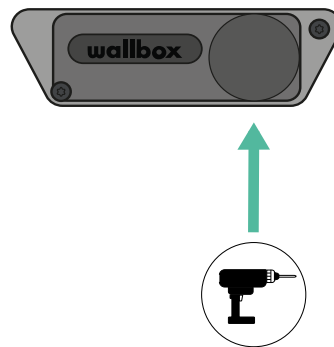

3. Using a flat screwdriver, make an incision in the 3-exit grommet.

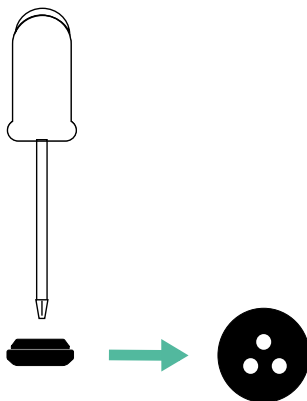

4. Insert the grommet in the hole on the communication lid.

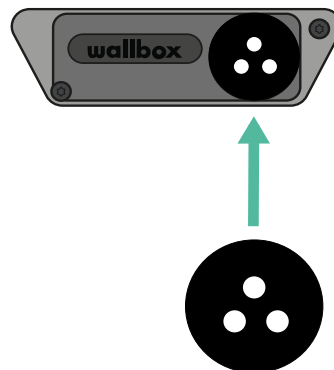

INSTALLATION WITH QUASAR V2H

Communication wiring between the charger and the meter

1. Insert the communication wire through the grommet.

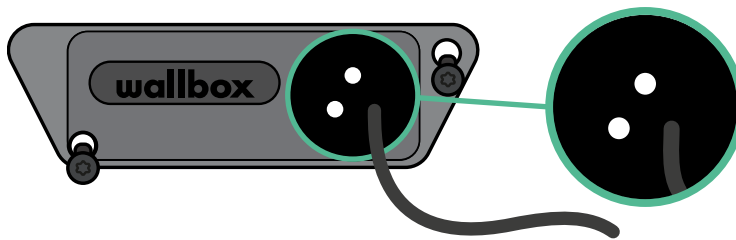

2. Install the meter following the instructions in the Meter Wiring Guide included in the package.
3. Wire the meter and the charger by following the relevant scheme below based on the model of your meter.



Important

It is mandatory to use a STP class 5E cable, use only 1 wire of each twisted pair. Remember that the communication wiring must not be more than 500m long.



Important

Remember that you need to use only one hole of the 3-exit grommet for each communication line.

INSTALLATION WITH QUASAR V2H

EM 112

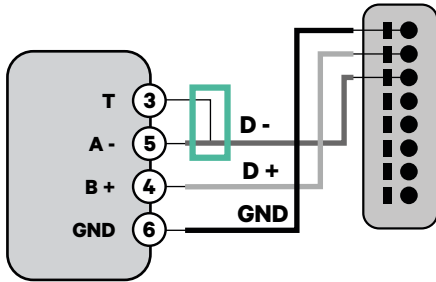

EM 340

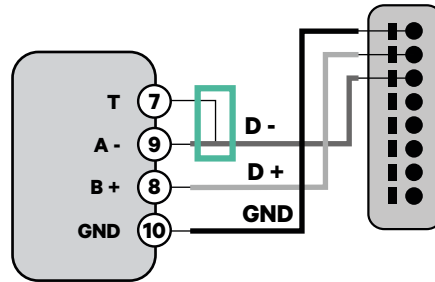

EM 330

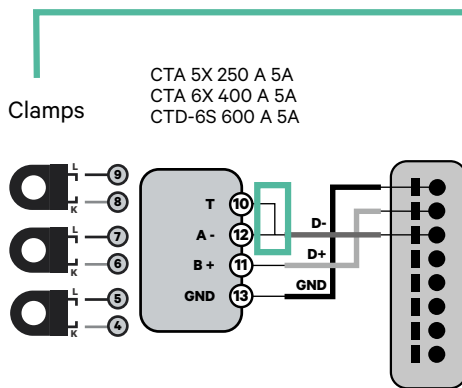

N1 CT

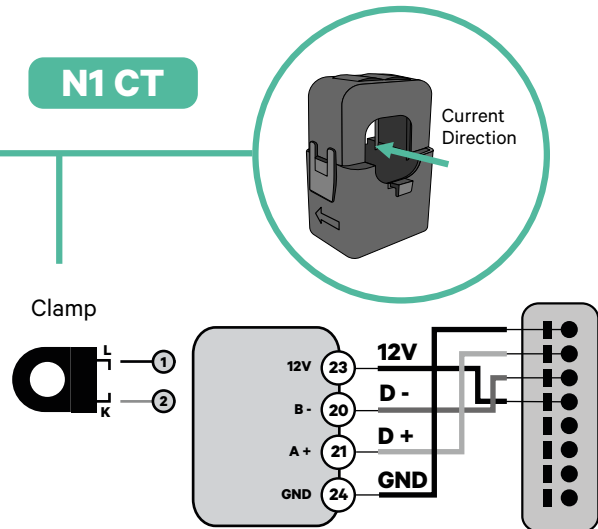

! For the EM330 configuration refer to the **Appendix**.

! For the N1CT installation, refer to the **Appendix**.

Pro MOD2

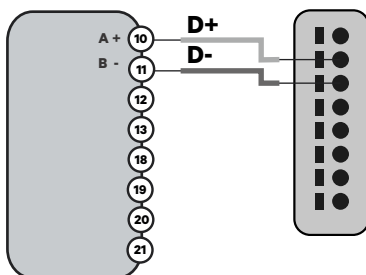

Pro 380 MOD

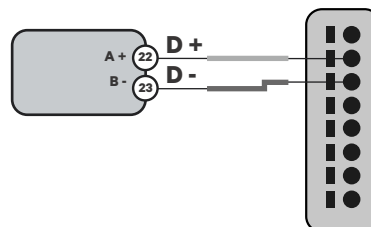

Important

Remember to check the Compatibility Table of each meter.

INSTALLATION WITH QUASAR V2H

Terminating resistance activation and current selector configuration

1. Link the communication connector to the board. Refer to the picture below.

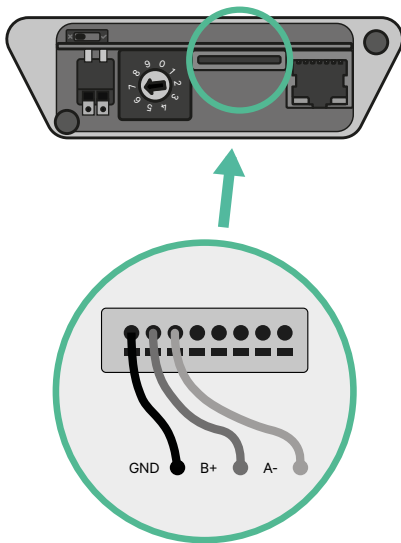

2. Put the rotary switch into a position between 1 and 7, depending on the maximum current that can be supplied from the charging network.

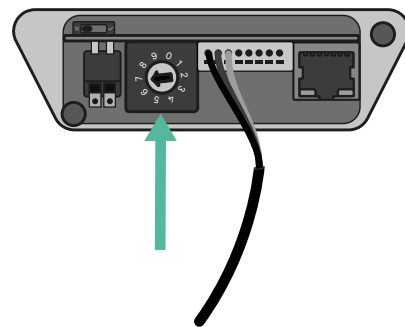

See the matrix below. This value must be the lower out of the main switch rated current MCB (not the RCD) and the contract tariff.

POSITION	0	1	2	3	4	5	6	7	8	9
CURRENT (A)	R	6	10	13	16	20	25	32	R	R

3. Close the communication lid and tighten the screws.

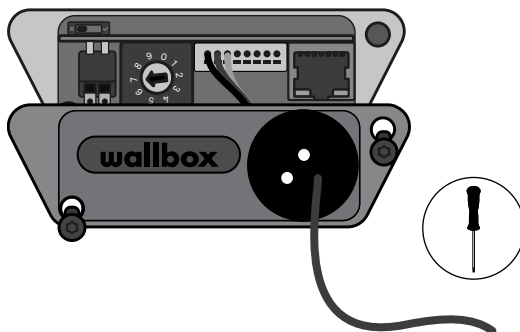

Note: Only Max Current > 6A per phase is accepted for a correct performance. In case of doubts, contact Wallbox Service.

INSTALLATION WITH PULSAR MAX & PULSAR PRO

Getting started

Important Notes

- A.** Install the charger following the instructions in the **Pulsar Max Installation Guide** or the **Pulsar Pro Installation Guide**. Refer to the user guide on the **Wallbox Help Center** for more information.
- B.** Only energy meters provided by Wallbox are compatible with Wallbox chargers.
- C.** Installations should be performed only by qualified personnel in accordance with applicable local regulations.
- D.** Update the Wallbox charger with the latest software version before installing the energy meter. Refer to the instructions for updating the charger on the **Wallbox Help Center** for more information.
- E.** Ensure that the charger is powered off and its cover is removed before connecting the energy meter. Close the charger properly after the installation.
- F.** After installing the charger, connect the energy meter before closing your charger. In case the energy meter is to be connected to a previously installed charger, open it to connect the energy meter.

Inside the Package

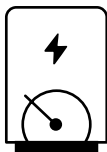

Energy Meter



Grommet

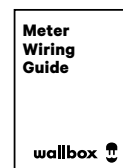

Meter Wiring Guide

INSTALLATION WITH PULSAR MAX & PULSAR PRO

Getting started

General Characteristics

	Power Boost	Eco-Smart	Power Sharing	Dynamic Power Sharing
Primary Chargers	1	1	1	1
Secondary Chargers	-	-	1-99	1-99
Communication protocol	Modbus RTU	Modbus RTU	Modbus RTU	Modbus RTU
Maximum total length between the first and the last charger of the chain	-	-	250m	250m
Maximum length between the wiring of the Primary charger and the Energy Meter	500m	500m	-	500m
Terminating Chargers	1	1	2	2
Maximum Phase Current configurable	Minimum between main switch rated (MCB) and the contract tariff	Minimum between main switch rated (MCB) and the contract tariff	Minimum between main switch rated (MCB) and the contract tariff	Minimum between main switch rated (MCB) and the contract tariff
Configurable installation maximum current	Installation main switch rated current (MCB)	Installation main switch rated current (MCB)	Installation main switch rated current (MCB)	Installation main switch rated current (MCB)
myWallbox	Super admin or admin account and basic subscription	Super admin or admin account and basic subscription	Super admin or admin account and basic subscription	Super admin or admin account and standard subscription

Meter Compatibility Table

Meters	Power Boost	Eco-Smart	Dynamic Power Sharing
EM340	✓	✓	✓
EM112	✓	✓	✓
SPM1-100-AC	✓	✗	✓
EM330 CTA 5X 250 A 5A	✓	✓	✓
EM330 CTA 6X 400 A 5A	✓	✓	✓
EM330 CTA 6X 600 A 5A	✓	✓	✓
N1CT	✓	✓	✓
PRO2 MOD	✓	✓	✓
PRO380 MOD	✓	✓	✓

INSTALLATION WITH PULSAR MAX & PULSAR PRO
Power Boost and Eco-Smart

Tools

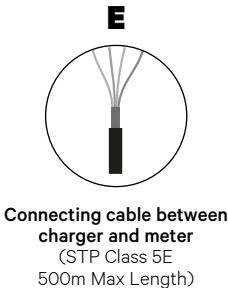
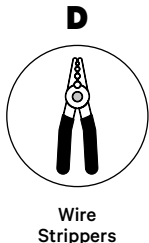
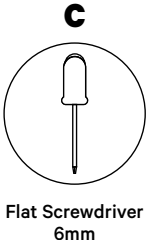
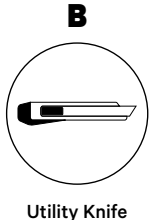
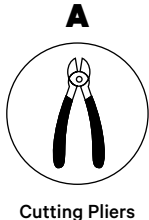

Refer to the **Pulsar Max Installation Guide** or the **Pulsar Pro Installation Guide** to know more about the tools required to install the charger.

INSTALLATION WITH PULSAR MAX & PULSAR PRO

Power Boost and Eco-Smart

Place the energy meter after the fuse box (D) and the RCDs+MCDBs (G), just before the charger (I).

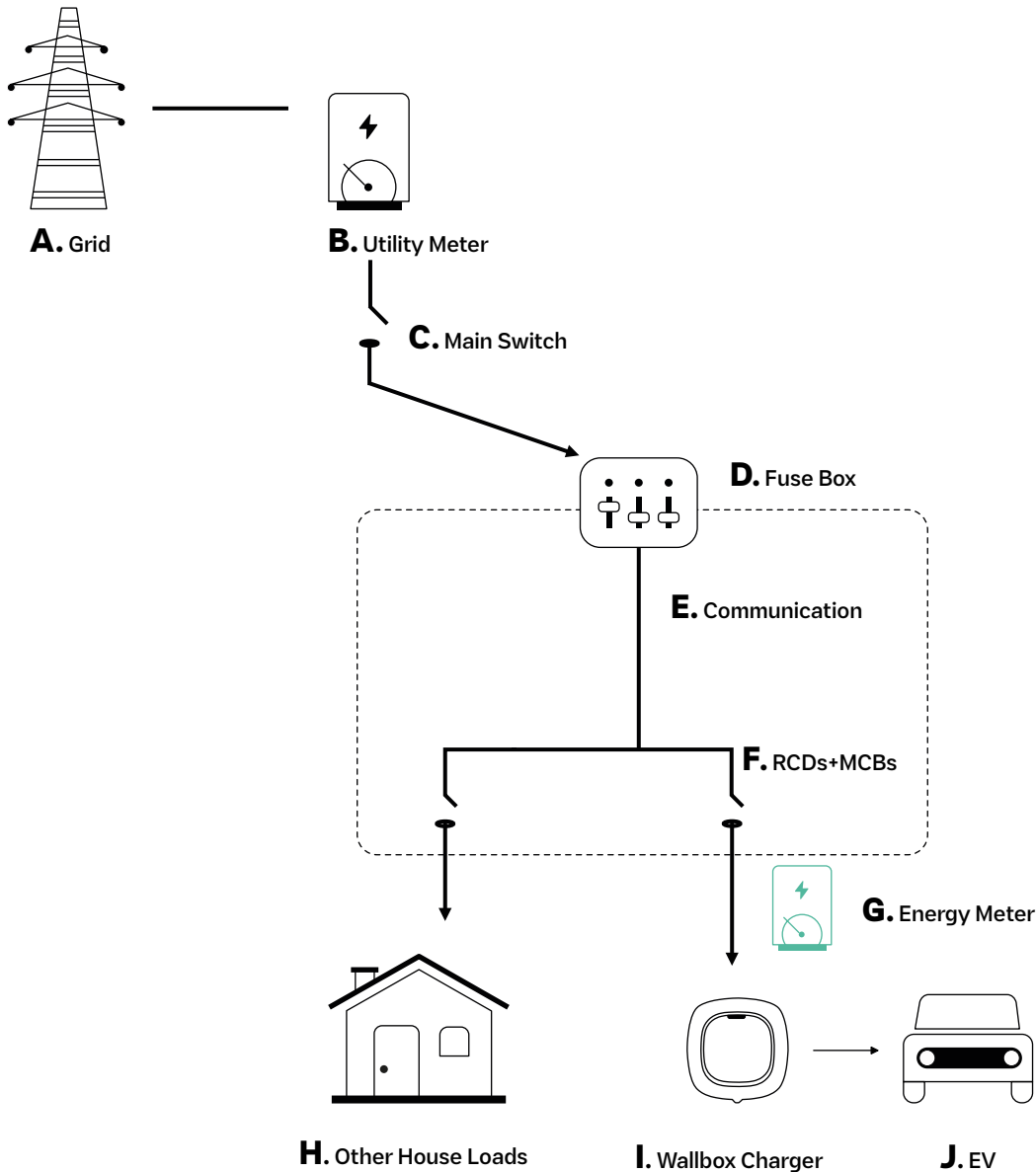

INSTALLATION WITH PULSAR MAX & PULSAR PRO

Power Boost and Eco-Smart

Before Installation

- Ensure that the power is turned off during the installation.
- Separate the communication wires from the power ones.

Preparation

- 1.** Make a hole at the central grommet, using a small flat screwdriver.

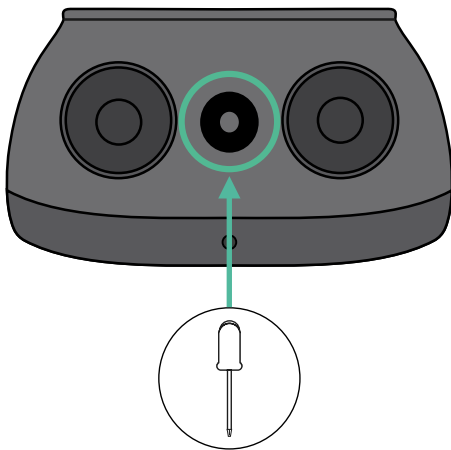

INSTALLATION WITH PULSAR MAX & PULSAR PRO

Power Boost and Eco-Smart

Pulsar Max Installation Guide

Install the charger following the instructions in the **Pulsar Max Installation Guide** or the **Pulsar Pro Installation Guide**.



Important

Ensure to not close the cover of the charger.

Communication wiring between the charger and the meter

- 1.** Keep the power turned off during the installation.
- 2.** Insert the communication wire through the grommet.

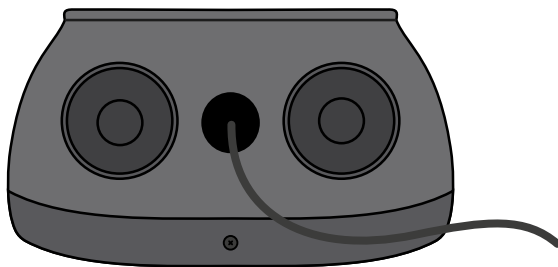

- 3.** Install the meter following the instructions in the Meter Wiring Guide included in its package.
- 4.** Wire the meter and the charger by following the relevant scheme below based on the model of your meter.



Important

It is mandatory to use an STP class 5E cable. Employ only 1 wire of each twisted pair and keep in mind that the communication wiring must not be more than 500m long.



Important

Insert only one cable in each grommet.

INSTALLATION WITH PULSAR MAX & PULSAR PRO Power Boost and Eco-Smart

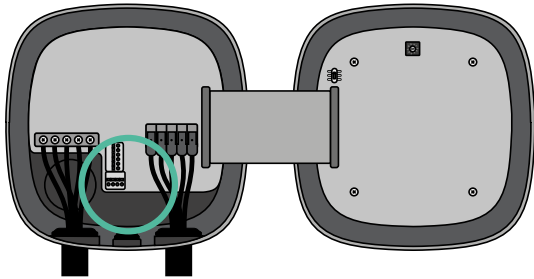

EM 112

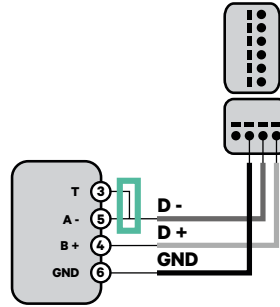

EM 340

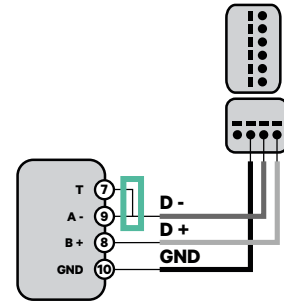

EM 330

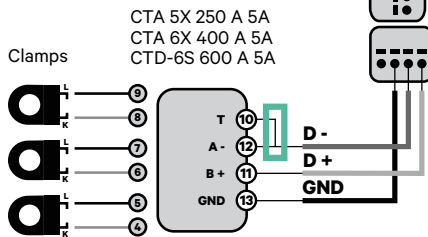
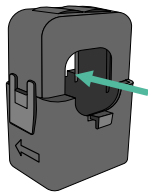

! For the EM330 configuration refer to the **Appendix**.

N1 CT

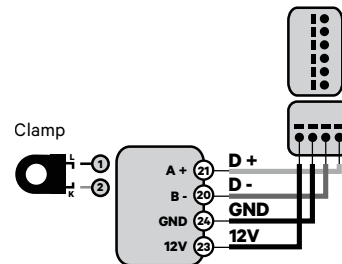

! For the N1CT installation, refer to the **Appendix**.

P1 Port

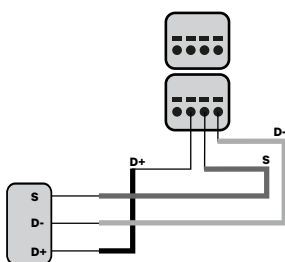

! For the P1 Port installation, refer to the **Appendix**.

SPM1-100-AC

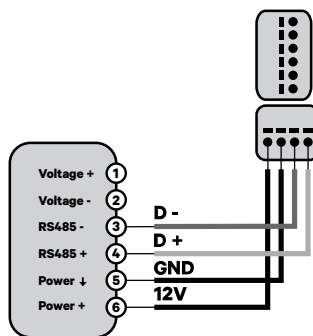

Pro MOD2

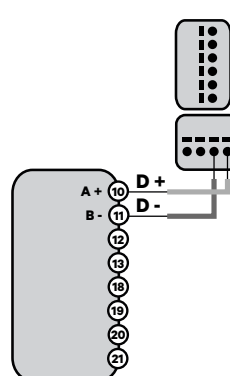

Pro 380 MOD

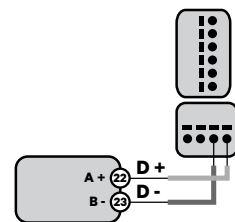

Important

Remember to check the Compatibility Table of each meter.

INSTALLATION WITH PULSAR MAX & PULSAR PRO

Power Boost and Eco-Smart

Terminating resistance activation and current selector configuration

1. Put the Power Boost switch on the T position.
2. Put the rotary switch into a position between 1 and 7, depending on the maximum current that can be supplied from the charging network.

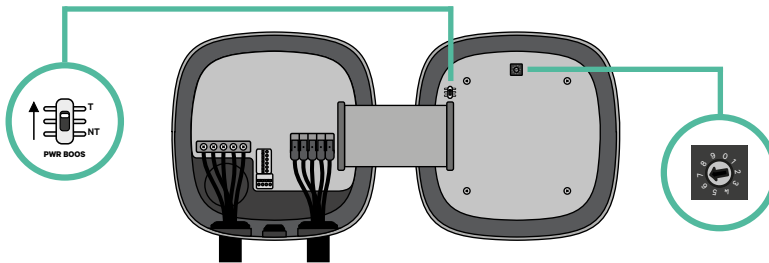

3. See the matrix below. This value must be equal or lower than the MCB protecting the Wallbox power line.

POSITION	0	1	2	3	4	5	6	7	8	9
CURRENT (A)	R	6	10	13	16	20	25	32	R	R

Note: Only Max Current > 6A per phase is accepted for a correct performance. In case of doubt, contact Wallbox Service.

4. Close the cover of the charger following the instructions in the chargers' Installation guides.
5. Once the installation is complete, do not forget to activate and finalise the Eco-Smart and Power Boost configuration in the myWallbox app. You can follow **this guide to the process for Eco-Smart** and **this one for Power Boost**.

INSTALLATION WITH PULSAR MAX & PULSAR PRO

Power Sharing

Tools

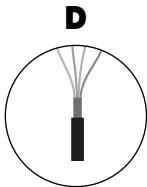
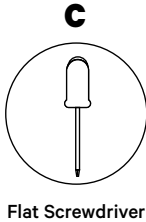
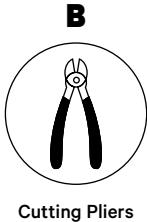
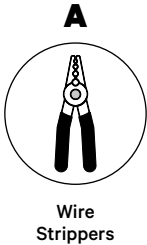

Connecting cable between charger and charger (UTP or STP CAT 5E 250m Max Length)

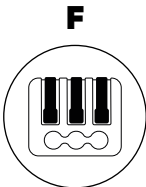
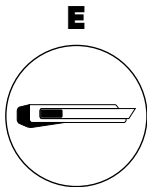

Three pole lever connectors (for small communication wires)



The installer has the responsibility to decide if the installation requires a UTP or STP 3rd wire to be used as a reference (GND).

Refer to the **Pulsar Max Installation Guide** or the **Pulsar Pro Installation Guide** to know more about the tools required to install the charger.

INSTALLATION WITH PULSAR MAX & PULSAR PRO

Power Sharing



In order to use the Power Sharing function, **it must be used only between Pulsar Max and Pulsar Pro**, as they are compatible. Therefore they cannot be used with Power Sharing if they are paired with Pulsar Plus, Commander 2 and Copper SB.

Before Installation

- Ensure that the power is turned off during the installation.
- Separate the communication wires from the power ones.

Preparation

- 1.** Make a hole at the central grommet, using a small flat screwdriver.

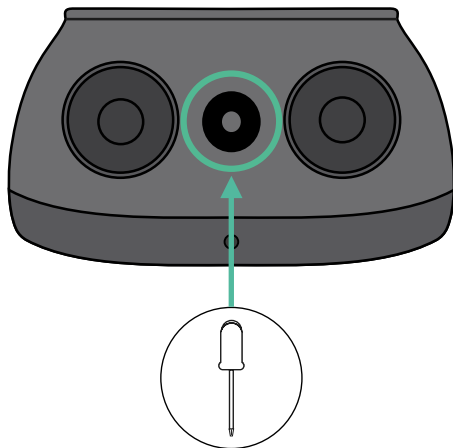

INSTALLATION WITH PULSAR MAX & PULSAR PRO

Power Sharing

Wiring the system

1. Ensure that the power is turned off during the installation.
2. Insert the communication wire (UTP or STP 5E cable) through the grommet.

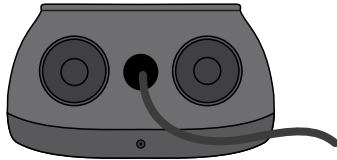

3. Check the position of the 6 pin connector.

Single Phase

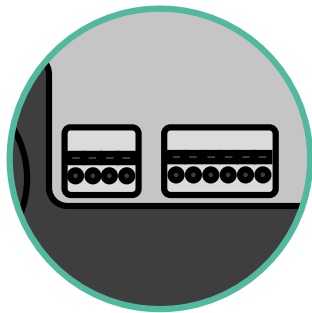

Three phase

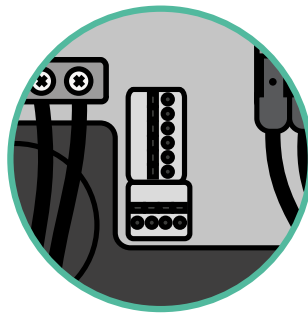

4. Once located the connector, start cabling the first charger of the chain. Check the Tools section to check if you need to use a third wire (GND).

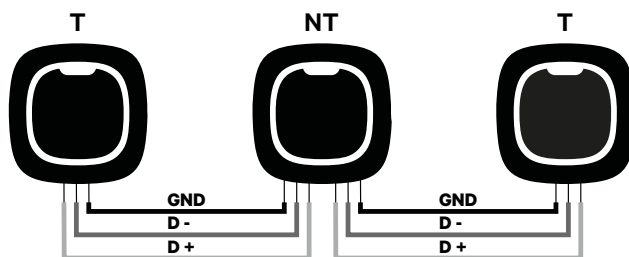

Important

- Power sharing works up to 100 chargers for each installation. Among them, one is primary and 99 are secondary. The maximum distance the communication wiring can reach is 250m.

Note: Only Max Current > 6A per phase is accepted for a correct performance. In case of doubts, contact Wallbox Service.

Refer to the chargers' Installation guides for more information.

INSTALLATION WITH PULSAR MAX & PULSAR PRO

Wiring the System

Terminating settings

- 1. Once the cabling is completed, you need to activate the termination resistors. The first and the last charger will always be terminating (T) with non terminating (NT) chargers between them.

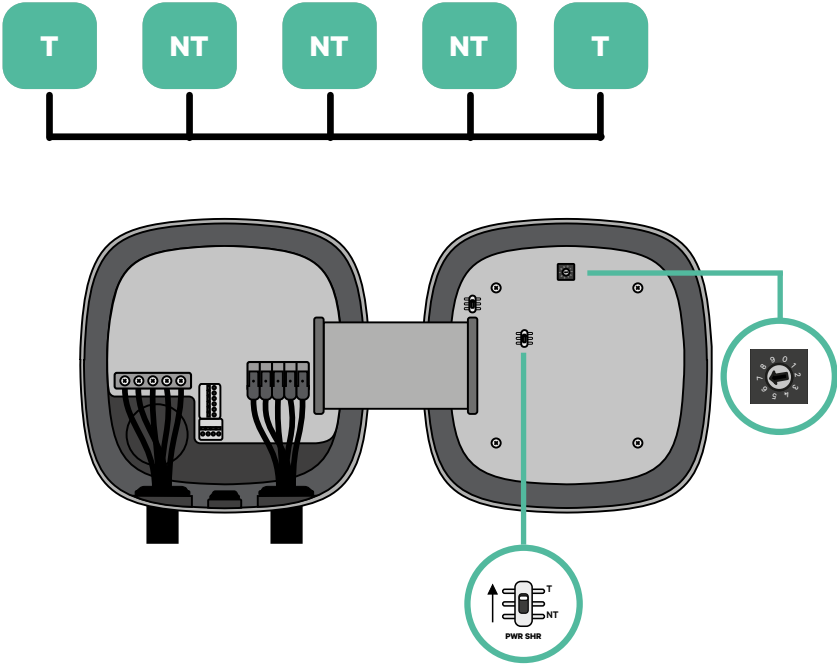

INSTALLATION WITH PULSAR MAX & PULSAR PRO

Wiring the System

2. Once the termination resistors are set up, place the current selector of each charger following the information. Put the rotary switch into a position between 1 and 7 depending on the maximum current that can be supplied from the charging network.

POSITION	0	1	2	3	4	5	6	7	8	9
MAX CURRENT	R	6	10	13	16	20	25	32	R	R



Important

Make sure that the selector does not point to 0, 8 and 9.

3. Close the cover of your charger by following the instructions in the respective **Installation Guide**.
4. Once the installation is complete, do not forget to activate and finalise the Power Sharing configuration in the myWallbox app. You can follow **this guide** to the process.

INSTALLATION WITH PULSAR MAX & PULSAR PRO

Power Sharing

Adding chargers in the future:

If you anticipate adding chargers to the system in the future, there are two ways you can prepare the system now to make it ready for Power Sharing.

Option 1: Place a bus disconnecter to accommodate future chargers as shown in the option 1 wiring scheme below. This option avoids the need for reopening the existing chargers and hence is the recommended option.

Option 2: Truncate the existing bus to add new charger(s) as shown in the option 2 wiring scheme below:

1. Open the charger following the installation guide of your Pulsar Max/Pulsar Pro charger.
2. Set the Power Sharing terminating resistor to NT, establish the communication wiring as explained above and close the charger.



Important

New chargers may be placed anywhere physically in relation to the existing chargers as long as you follow these rules:

- You maintain the logic of the daisy chain.
- You respect the cabling polarity as described above under “Installation”.

Wherever a future added charger is placed, the most important rule to follow is the logic of the daisy chain. For example, in the image below, the new charger is placed before the Terminating charger on the right side of the daisy chain.

Option 1:

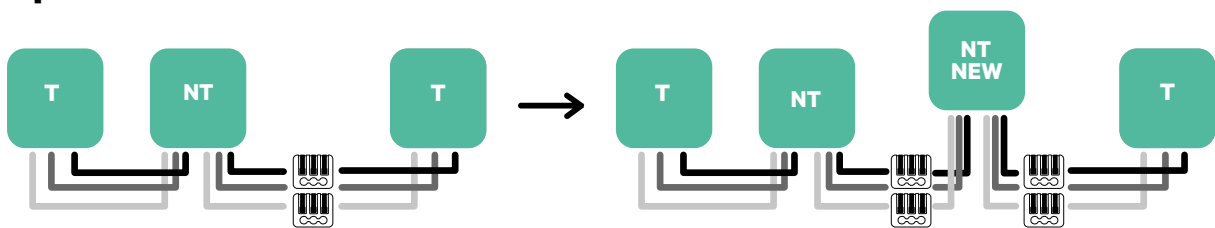

Option 2:

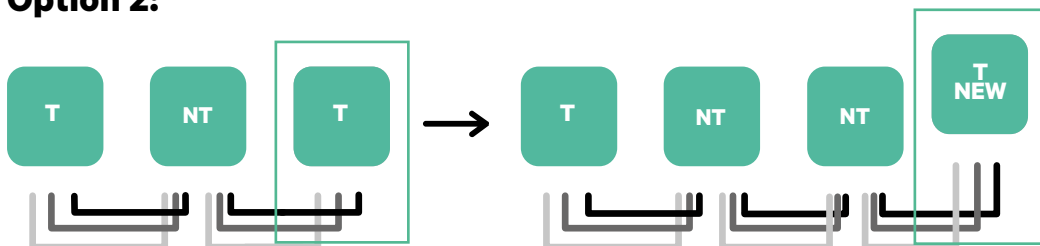

Open this existing chargers

INSTALLATION WITH PULSAR MAX & PULSAR PRO

Dynamic Power Sharing

Tools

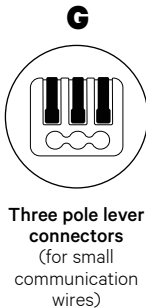
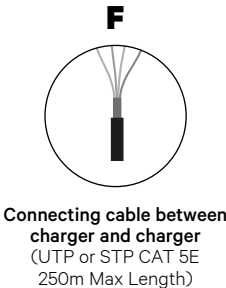
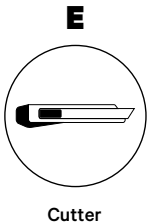
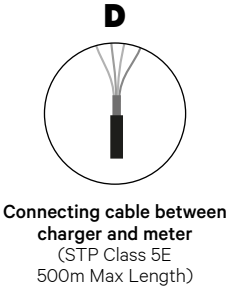
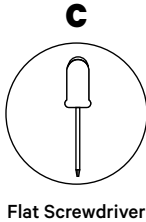
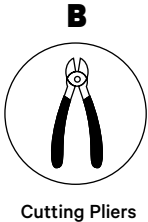
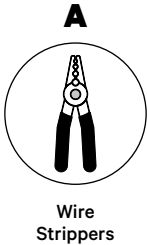

The installer has the responsibility to decide if the installation requires a UTP or STP 3rd wire to be used as a reference (GND).

Refer to the **Pulsar Max Installation Guide** or the **Pulsar Pro Installation Guide** to know more about the tools required to install the charger.

INSTALLATION WITH PULSAR MAX & PULSAR PRO

Dynamic Power Sharing



Pulsar Pro and Pulsar Max are compatible, but aren't compatible with Pulsar Plus, Commander 2 and Copper SB, so Dynamic Power Sharing should be used only between Pulsar Max and Pulsar Pro.

Before Installation

- Ensure that the power is turned off during the installation.
- Separate the communication wires from the power ones.

Preparation

- 1.** Make a hole in the central grommet, using a small flat screwdriver.

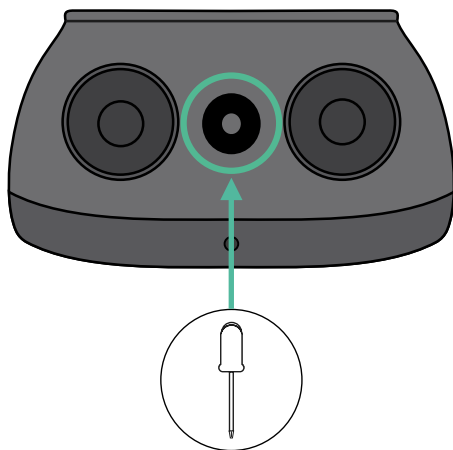

INSTALLATION WITH PULSAR MAX & PULSAR PRO

Dynamic Power Sharing

Pulsar Max & Pulsar Pro Installation Guide

Install the charger as detailed in the [Pulsar Max Installation Guide](#) or the [Pulsar Pro Installation Guide](#).



Important

Ensure not to close the cover of the charger.

Communication wiring between the charger and the meter

- 1.** Keep the power turned off during the installation.
- 2.** Insert through the grommet the two communication wires, one for meter communication and the other one for communication between chargers.

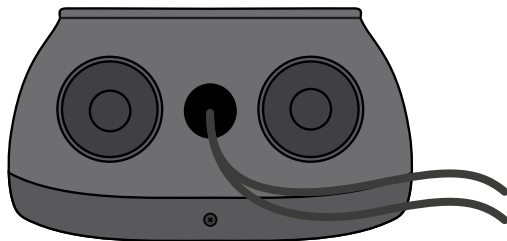

- 3.** Install the meter following the instructions in the Meter Wiring Guide included in the package.
- 4.** Wire the meter and the charger by following the relevant scheme below based on the model of your meter.



Important

For the communication with the meter it is mandatory to use STP class 5E cable and remember the communication wiring must not be longer than 500 meters.



Important

For the communication between chargers it is mandatory to use UTP or STP class and remember that all the chargers chain must not be longer than 250 meters.

INSTALLATION WITH PULSAR MAX & PULSAR PRO

Dynamic Power Sharing

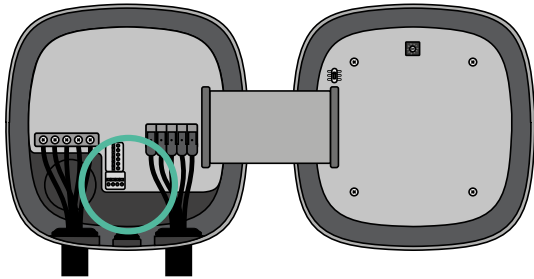

EM 112

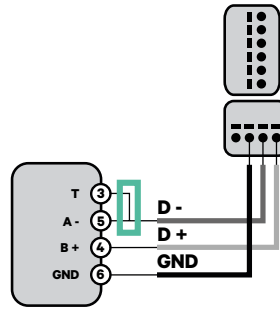

EM 340

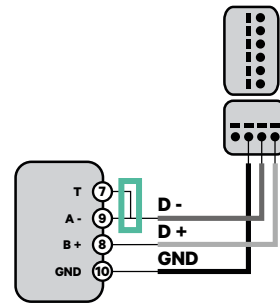

EM 330

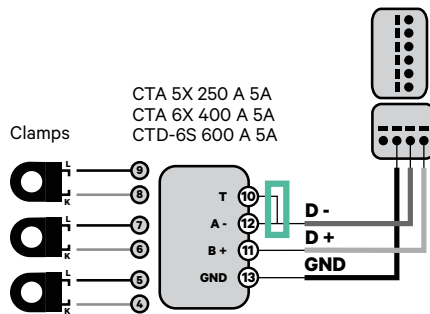
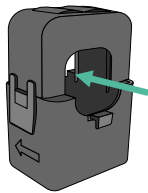

! For the EM330 configuration refer to the **Appendix**.

N1 CT

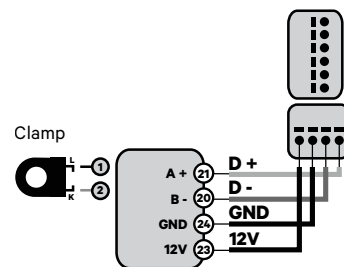

! For the N1CT installation, refer to the **Appendix**.

P1 Port

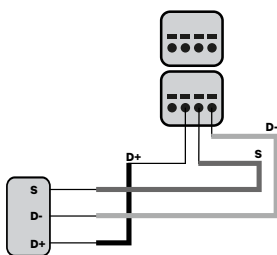

! For the P1 Port installation, refer to the **Appendix**.

SPM1-100-AC

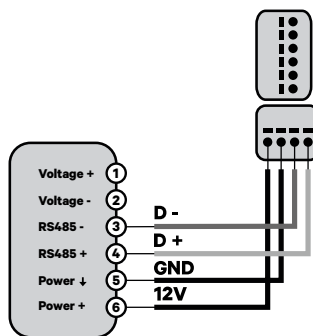

Pro MOD2

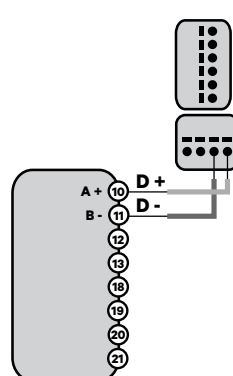

Pro 380 MOD

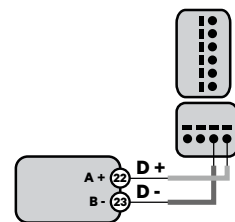

Important

Remember to check the Compatibility Table of each meter.

INSTALLATION WITH PULSAR MAX & PULSAR PRO

Dynamic Power Sharing

Wiring the system

1. Ensure that the power is turned off during the installation.
2. Check the position of the 6 pin connector.

Single Phase

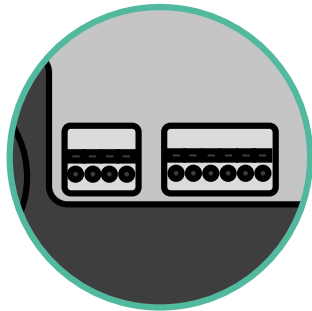

Three phase

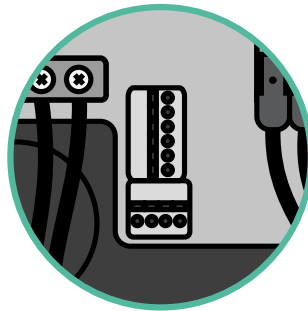

4. Once located the connector, start cabling the the first charger of the chain. Check the Tools section to check if you need to use a third cable (GND).

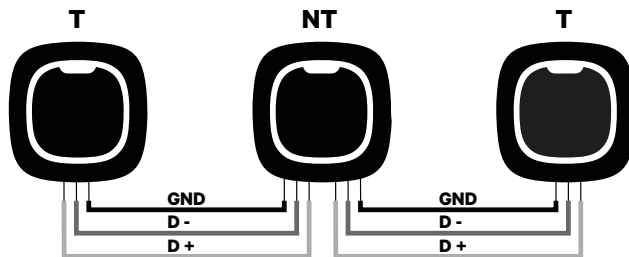

Important

- Dynamic Power Sharing works up to 100 chargers for each installation. Among them, one is primary and 99 are secondary. The maximum distance the communication wiring can reach is 250m.

Note: Only Max Current > 6A per phase is accepted for a correct performance. In case of doubts, contact Wallbox Service.

Refer to the **Pulsar Max Installation Guide** or the **Pulsar Pro Installation Guide** for more information.

INSTALLATION WITH PULSAR MAX & PULSAR PRO

Dynamic Power Sharing

Terminating settings

1. Once the cabling is complete, you need to activate the terminating resistors. First set up Power Boost into T only for the charger that is connected into meter. Then, set up Power Sharing, the first and the last charger will always be terminating (T) with non terminating (NT) chargers between them.

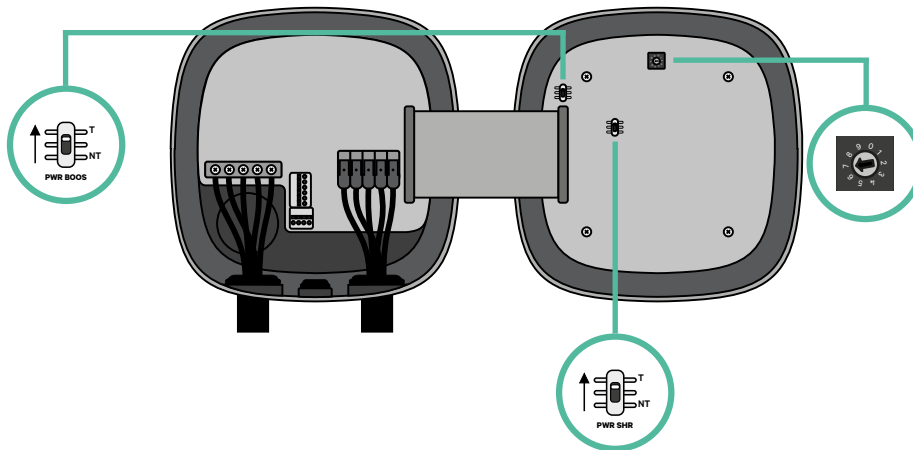

Important

Only for Pulsar Max Rev A with a Temco clamp, set up the Power Boost into NT.

INSTALLATION WITH PULSAR MAX & PULSAR PRO

Dynamic Power Sharing

2. Once the termination resistors are set up, place the current selector of each charger following the information. Put the rotary switch into a position between 1 and 7 depending on the maximum current that can be supplied from the charging network.

POSITION	0	1	2	3	4	5	6	7	8	9
MAX CURRENT	R	6	10	13	16	20	25	32	R	R



Important

Make sure that the selector does not point to 0, 8 and 9.

3. Close the cover of your charger by following the instructions in the respective **Installation Guide**.
4. Once the installation is complete, do not forget to activate and finalise the Dynamic Power Sharing configuration in the myWallbox app. You can follow **this guide** to the process.

INSTALLATION WITH PULSAR MAX & PULSAR PRO

Dynamic Power Sharing

Adding chargers in the future:

If you anticipate adding chargers to the system in the future, there are two ways you can prepare the system now to make it ready for Dynamic Power Sharing.

Option 1: Place a bus disconnecter to accommodate future chargers as shown in the option 1 wiring scheme below. This option avoids the need of reopening the existing chargers and hence it is the recommended option.

Option 2: Truncate the existing bus to add new charger(s) as shown in the option 2 wiring scheme below.

1. Open the charger following the installation guide of your Pulsar Max/Pulsar Pro charger.
2. Set the terminating resistor Power Sharing into NT, make the communication wiring as explained above and then close the charger.



Important

New chargers may be placed anywhere physically in relation to the existing chargers as long as you follow these rules:

- You maintain the logic of the daisy chain.
- You respect the cabling polarity as described above under “Installation”.

Wherever a future added charger is placed, the most important rule to follow is the logic of the daisy chain. For example, in the image below, the new charger is placed before the Terminating charger on the right side of the daisy chain.

Option 1:

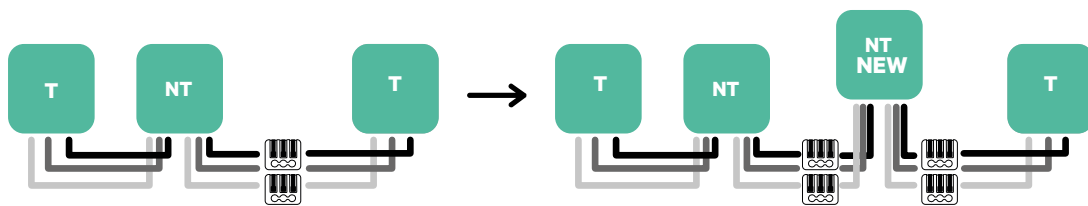

Option 2:

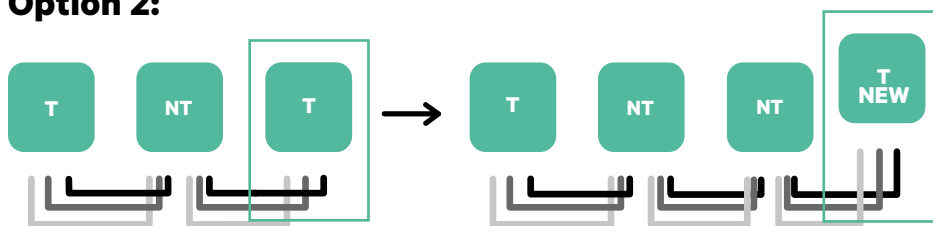

Open this existing chargers

Note: Check the terminating settings on page 83 to know when to set T or NT on the first and last charger of the installation.

! To install Dynamic Power Sharing with four chargers, check the **Appendix**.

CONFIGURATION

Power Boost

Enabling Power Boost

Follow these steps to activate Power Boost once you have installed your charger and its compatible energy meter:

- 1.** Make sure your Wallbox charger and myWallbox mobile app have the latest version available (you can check its version in your Play Store or App Store).
- 2.** Connect to your charger via Bluetooth.
- 3.** Log into the myWallbox app by filling in your credentials, or [register](#) if you do not have an account yet. If your charger is a Commander 2, you can also configure Power Boost on its touchscreen directly.

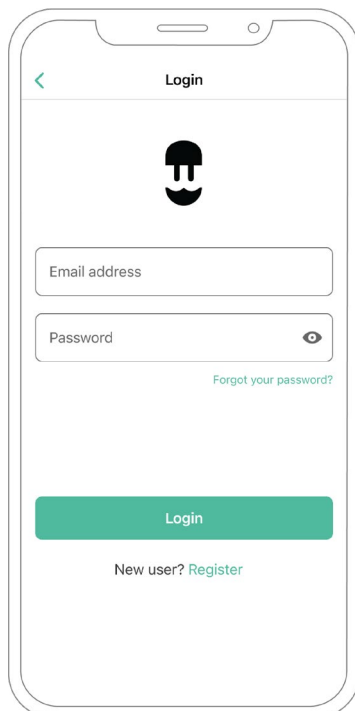

CONFIGURATION

Power Boost

- 4.** Select the charger you want to enable Power Boost for and stay within its Bluetooth range during all the following steps. If you did not link your charger to your myWallbox account yet, please follow [these instructions](#) to do so.

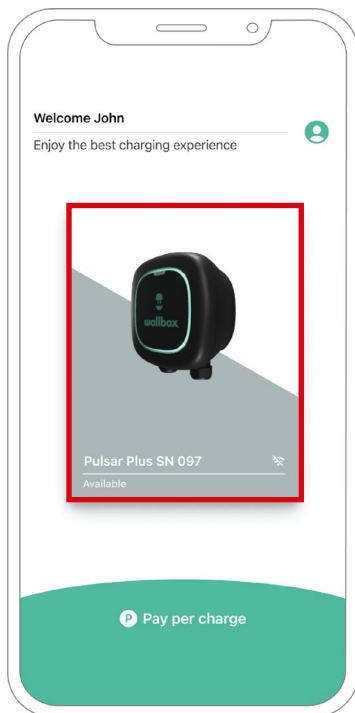

- 5.** Once the synchronization between your charger and your App is complete, go to Settings.

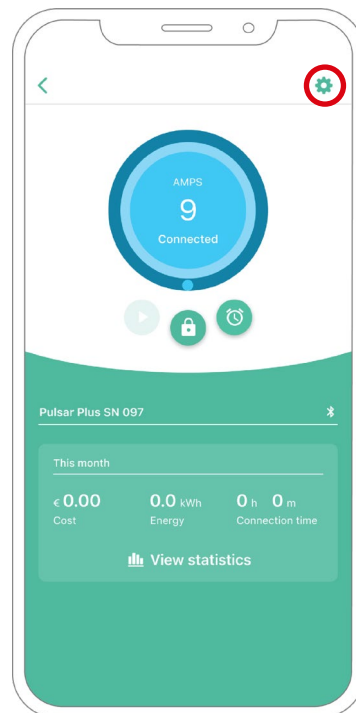

CONFIGURATION

Power Boost

6. Then click Upgrades.

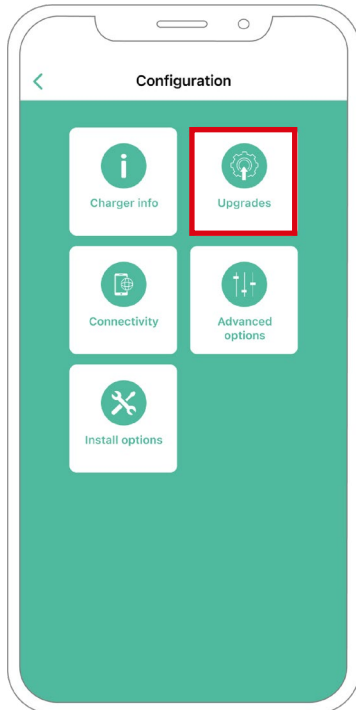

7. Click the Power Boost icon.

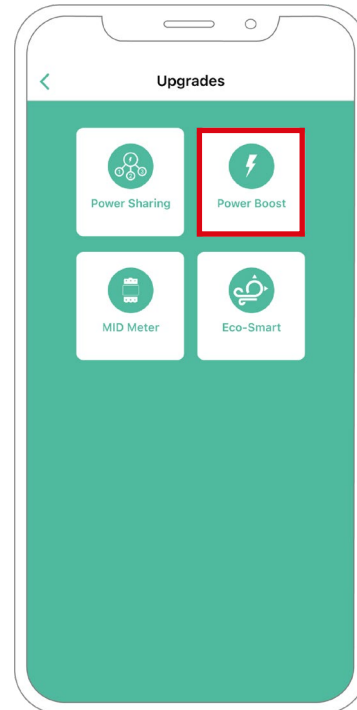

CONFIGURATION

Power Boost

8. Enable the Power Boost feature by switching the button to the ON position. In the Max current per phase field, specify the main breaker rated current or subscribed current (in amps), whichever is lower. Then, click Accept to enable Power Boost.

Important Only Max Current per phase greater than 6 amps is accepted for correct performance. In case of doubt, contact Wallbox Customer Service.

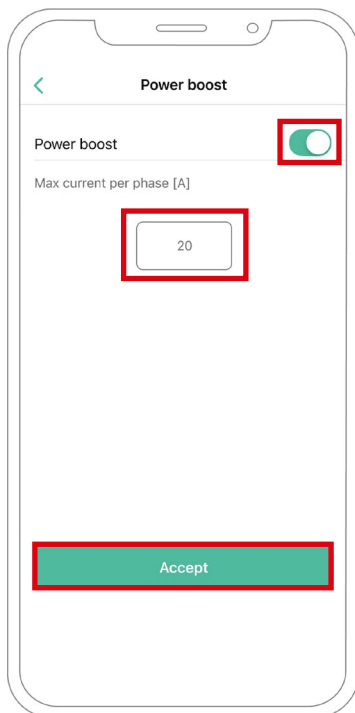

Troubleshooting steps in case Power Boost icon is not selectable

1. Power off and power on your charger.
2. Check all cables for correct installation.
3. Check if correct cable type is used.
4. Check if switch is settled correctly to “T” or “NT”.
5. Check if your charger [software](#) is up to date.
6. Make sure that you are connected through Bluetooth.

CONFIGURATION

Eco-Smart

Enabling Eco-Smart

Follow these steps to activate Eco-Smart once you have installed your charger and its compatible energy meter:

- 1.** Make sure your Wallbox charger and myWallbox mobile app have the latest version available (you can check its version in your Play Store or App Store).
- 2.** Connect to your charger via Bluetooth.
- 3.** Log into the myWallbox app by filling in your credentials, or [register](#) if you do not have an account yet.

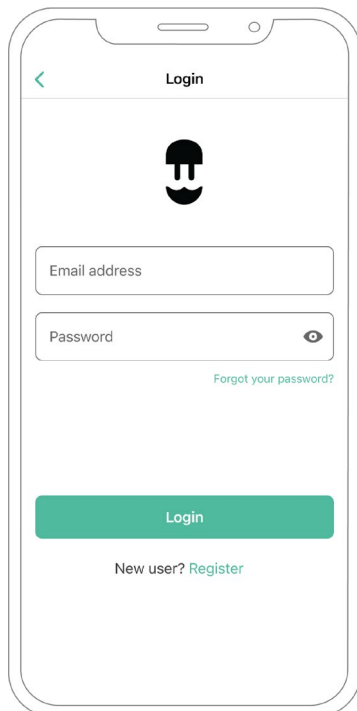

CONFIGURATION Eco-Smart

4. On the charger screen, select the charger you wish to activate the Eco-Smart feature for. If you did not link your charger to your myWallbox account yet, please follow [these instructions](#) to do so.



5. Once synchronization is complete, tap the cogwheel to access the Settings.

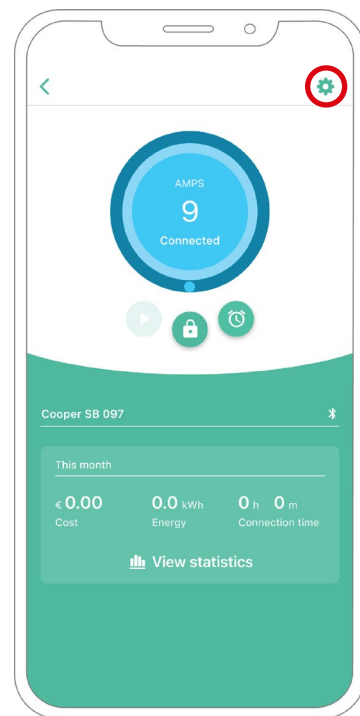

CONFIGURATION Eco-Smart

6. Click Upgrades.

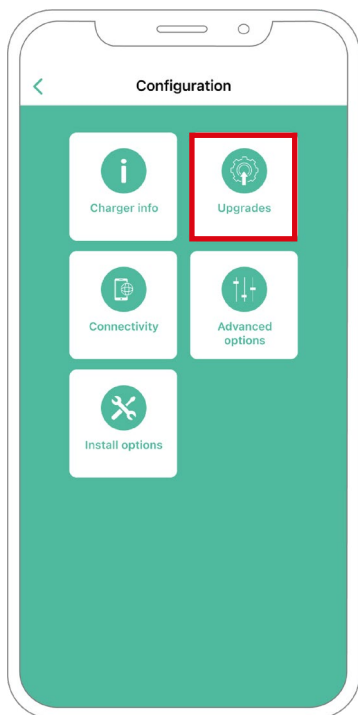

7. It is recommended to activate [Power Boost](#) (1) before enabling Eco-Smart. Once Power Boost is activated tap the Eco-Smart (2) feature to access its settings.

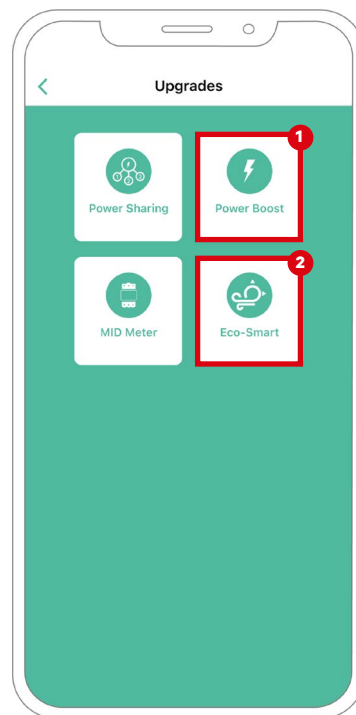

CONFIGURATION Eco-Smart

8. Tap “Let’s start” to start using Eco-Smart.

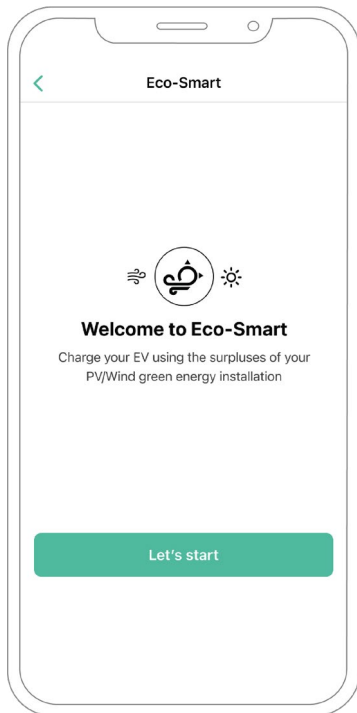

9. Enable the Eco-Smart feature by switching the button to the ON position.

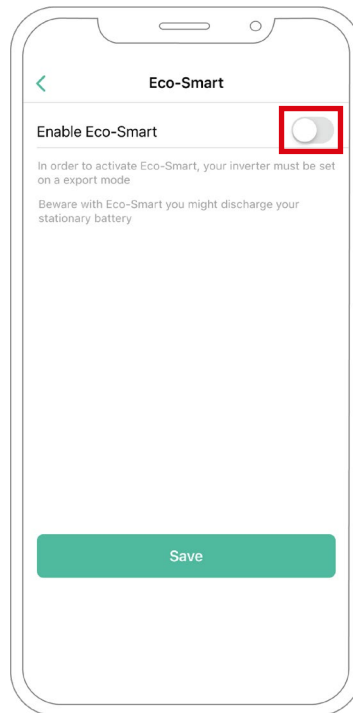

CONFIGURATION

Eco-Smart

- 10.** You now have a choice to select two Eco-Smart modes. Select the mode that you wish to use, Eco or Full-Green.

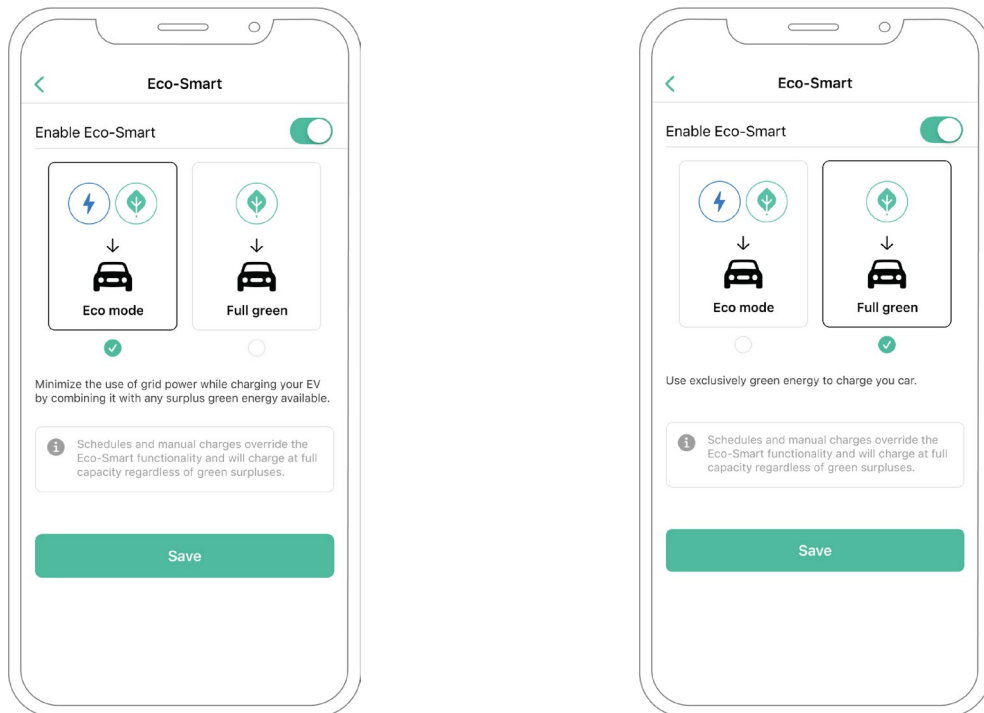

- 11.** Then click Save. The Eco-Smart feature is now activated with the mode you have selected.

Troubleshooting steps in case the Eco-Smart icon is not selectable

1. Power off and power on your charger.
2. Check all the cables for correct installation.
3. Check if the correct cable type is used.
4. Check if the switch is settled correctly to “T” or “NT”.
5. Check if your charger [software](#) is up to date.
6. Make sure that you are connected using Bluetooth.

CONFIGURATION

V2H

Enabling Vehicle to Home

Follow these steps to activate Vehicle to Home for your Quasar:

- 1.** Make sure your Wallbox charger and myWallbox mobile app have the latest version available (you can check its version in your Play Store or App Store).
- 2.** Connect to your charger via Bluetooth.
- 3.** Log into the myWallbox app by filling in your credentials, or [register](#) if you do not have an account yet.

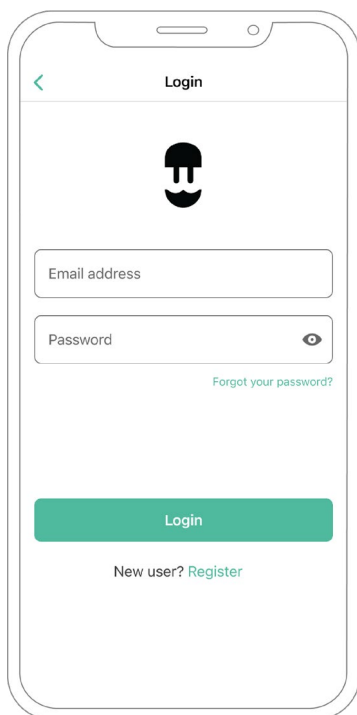

CONFIGURATION V2H

4. Select your charger and stay within its Bluetooth range during all the following steps. If you did not link your charger to your myWallbox account yet, please follow [these instructions](#) to do so.



5. To activate Vehicle to Home, you will first need to enable Power Boost. Please refer to the [Power Boost article](#) to learn how to activate it.

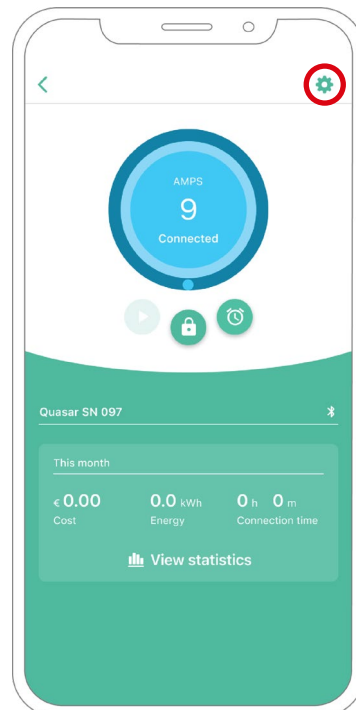

CONFIGURATION V2H

6. Once you have configured Power Boost properly and the synchronization between the charger and the app is complete (the charging wheel turns green), go to Settings.

7. Click Upgrades.

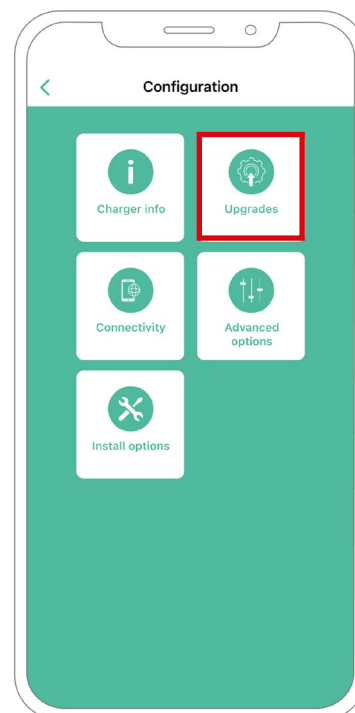

CONFIGURATION V2H

8. Then click Vehicle to Home.

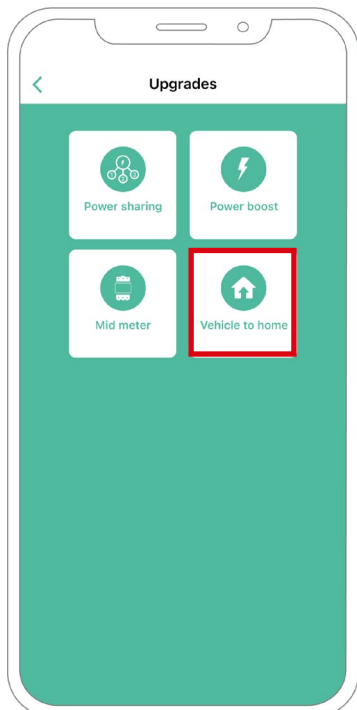

9. Enable the Vehicle to Home feature by switching the button to the ON position.

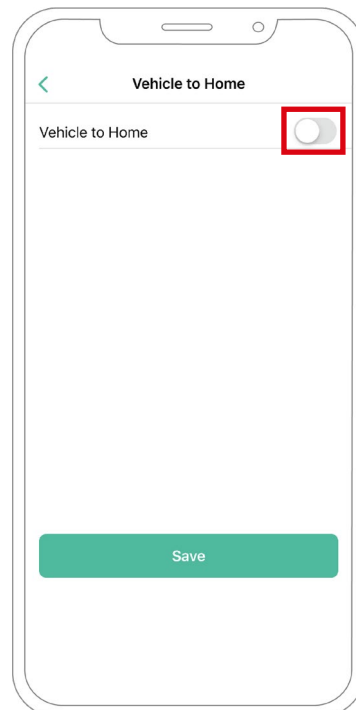

CONFIGURATION V2H

- 10.** In Max Current per phase of installation (in amps), specify the main breaker rated current. The value specified has to be equal to or greater than the MAX. CURRENT PER PHASE (in amps) set for Power Boost. Click Save.

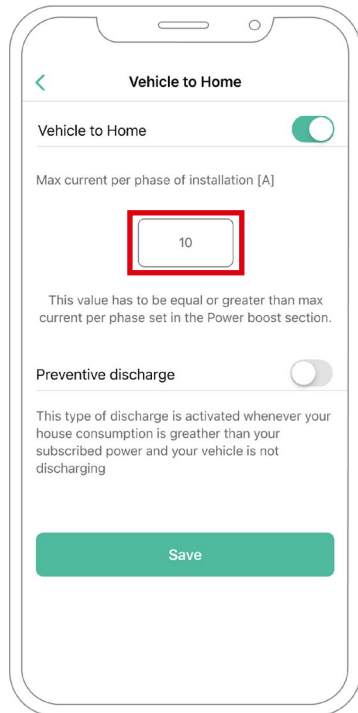

- 11. CASE 1:** If Max Current per phase of the installation is greater than Power Boost current, you need to turn on the Preventive discharge feature. Once done, click SAVE and Vehicle to Home will be fully configured.

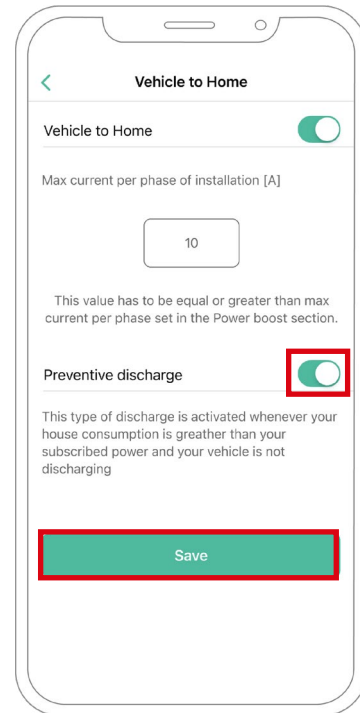

CONFIGURATION V2H

- 11. CASE 2:** If Max Current per phase set in Vehicle to Home is equal to Power Boost current per phase, just click SAVE and Vehicle to Home will be activated.

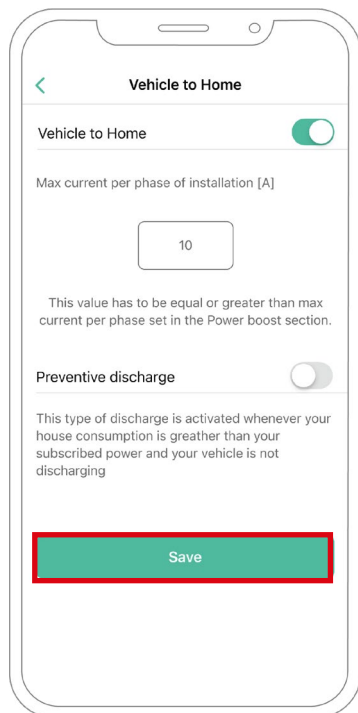

- 11. CASE 3:** If Max Current per phase of installation set in Vehicle to Home is lower than Power Boost current per phase, you will not be able to save this configuration and an error message will display. Set a value greater or equal to Power Boost current per phase to enable Vehicle to Home.

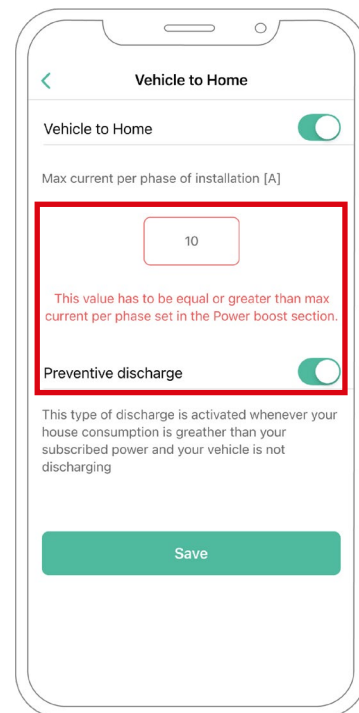

Troubleshooting steps in case the Vehicle to Home icon is not selectable

1. Power off and power on your charger.
2. Check all cables for correct installation.
3. Check if the correct cable type is used.
4. Check if the switch is settled correctly to "T" or "NT".
5. Check if your charger [software](#) is up to date.
6. Make sure that you are connected through Bluetooth.

CONFIGURATION

Power Sharing

Enabling Power Sharing

Follow these steps to activate Power Sharing for your charger:

- 1.** Make sure your Wallbox charger and myWallbox mobile app have the latest version available (you can check its version in your Play Store).
- 2.** Connect to your charger via Bluetooth.
- 3.** Log into the myWallbox app by filling in your credentials, or [register](#) if you do not have an account yet.

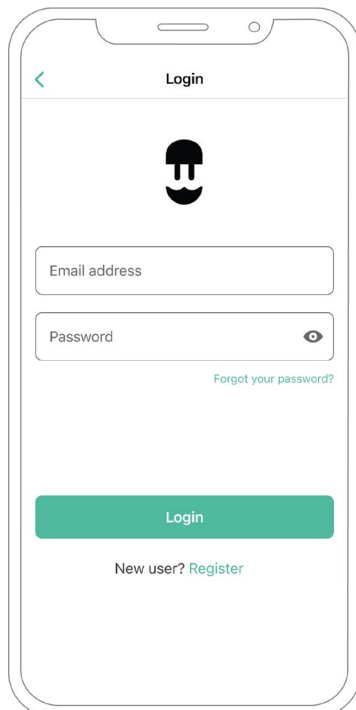

CONFIGURATION

Power Sharing

- 4.** With **Pulsar Plus, Commander 2** and **Copper SB** select the primary charger of the chain and stay within its Bluetooth range during all the following steps. With **Pulsar Max**, select any charger of the chain. If you did not link your charger to your myWallbox account yet, please follow [these instructions](#) to add your charger.

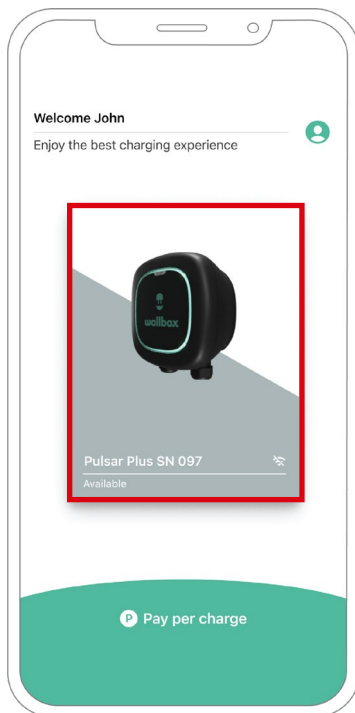

- 5.** Once your charger and myWallbox App are synchronized (the charging wheel will turn green on your app), go to Settings.

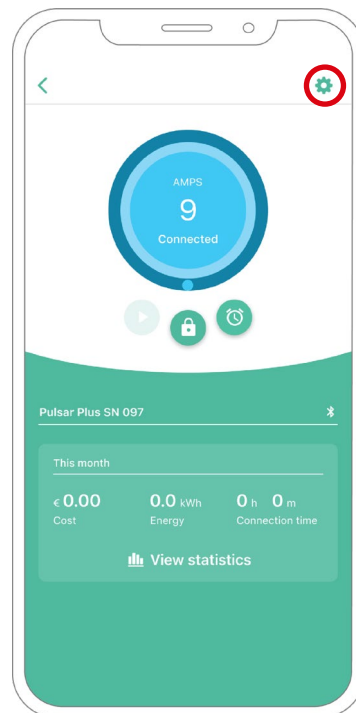

CONFIGURATION

Power Sharing

6. Click Upgrades.

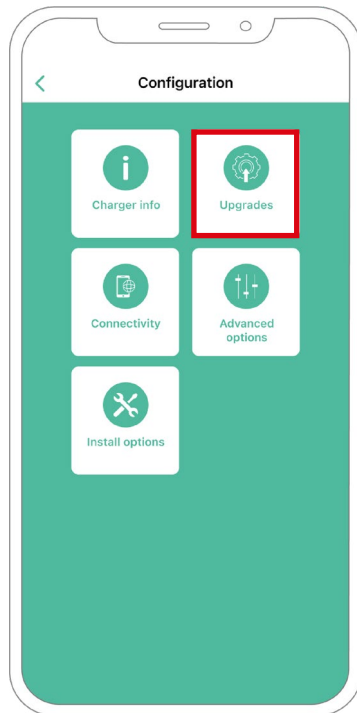

7. Then click the Power Sharing icon.

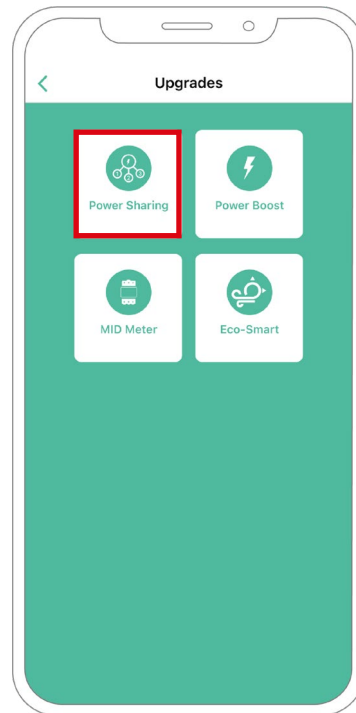

CONFIGURATION

Power Sharing

8. Indicate the Number of chargers that are present on the installation. In the Max. current per phase field, specify the max. rated current of the protection installed (MCB) to protect all chargers installation. Please note that only maximum current per phase greater than 6 amps is accepted for correct performance. In case of doubt, contact Wallbox Service.

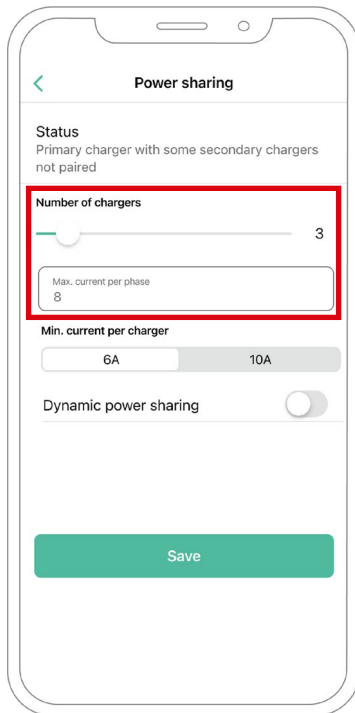

9. Define the Min. current per charger (in amps) that each charger will operate.

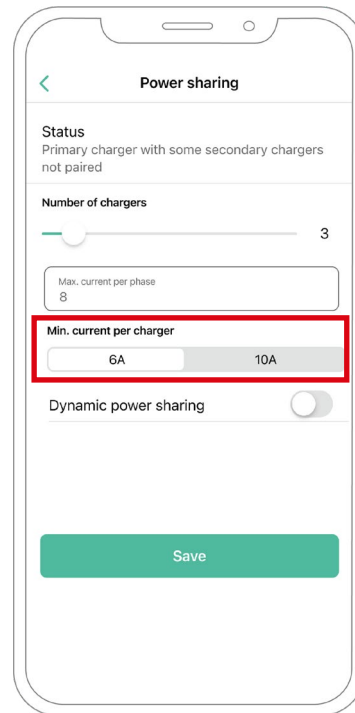

CONFIGURATION

Power Sharing

- 10.** Once you go through all the steps, click Save and ensure that the status “Primary charger with all secondary chargers paired” appears.

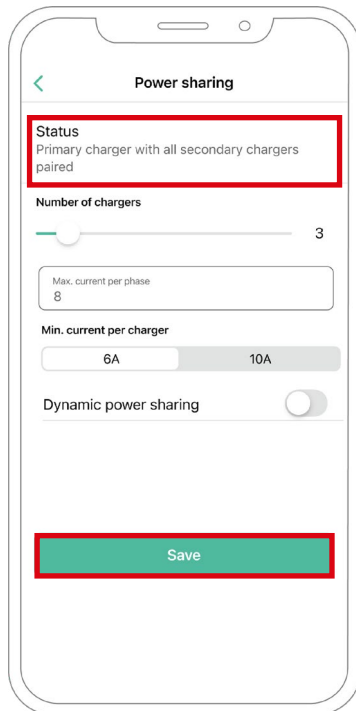

Troubleshooting steps in case the Power Sharing icon is not selectable

1. Power off and power on your charger.
2. Check all cables for correct installation.
3. Check if the correct cable type is used.
4. Check if the switch is settled correctly on “T” or “NT”.
5. Check if your charger [software](#) is up to date.
6. Make sure that you are connected through Bluetooth.

CONFIGURATION

Dynamic Power Sharing

Enabling Dynamic Power Sharing

- 1.** Make sure your Wallbox charger and myWallbox mobile app have the latest version available (you can check its version in your Play Store)
- 2.** Connect to your charger via Bluetooth.
- 3.** Log into the myWallbox app by filling in your credentials, or [register](#) if you do not have an account yet. If your charger is a Commander 2, you can also configure Dynamic Power Sharing on its touchscreen directly.

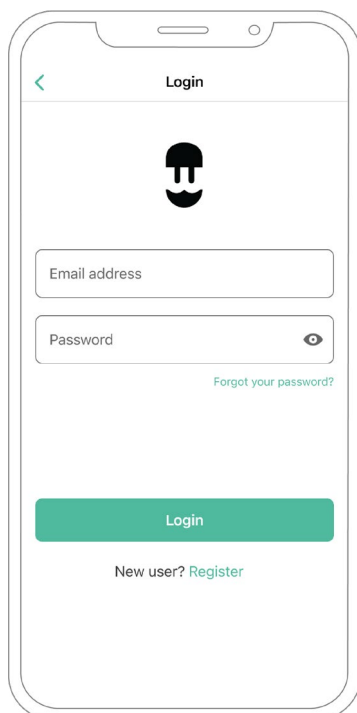

CONFIGURATION

Dynamic Power Sharing

4. Select the charger that is connected to the meter and stay within its Bluetooth range during all the following steps. If you did not link your charger to your myWallbox account yet, please follow [these instructions](#) to do so.

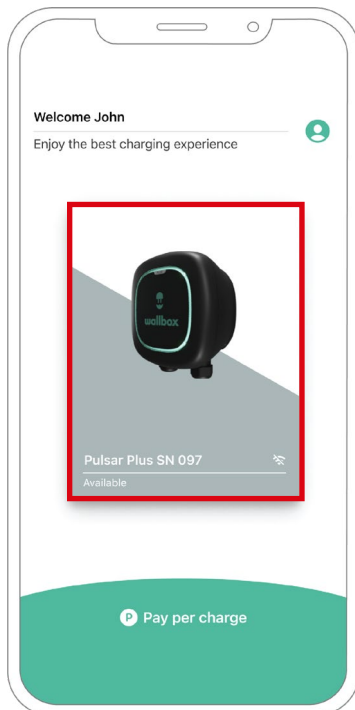

5. Once your charger and myWallbox App are synchronized, go to Settings.

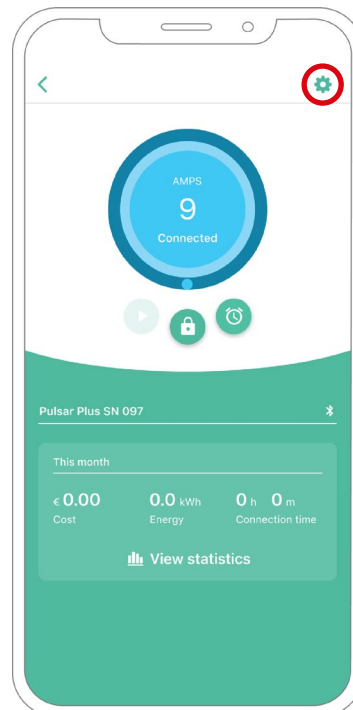

CONFIGURATION

Dynamic Power Sharing

6. Click Upgrades.

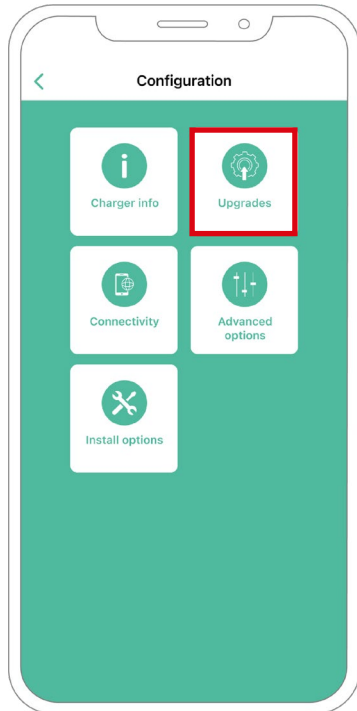

7. Click the Power Sharing icon.

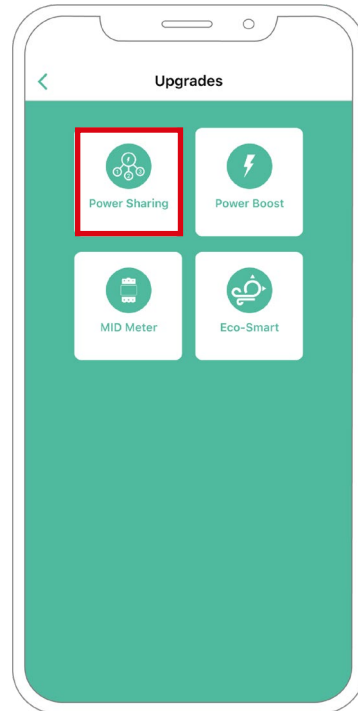

CONFIGURATION

Dynamic Power Sharing

- 8.** Indicate the Number of chargers present on the installation.
In the Max. current per phase field, specify the max. rated current of the protection installed (MCB) to protect all chargers installation. Please note that only Max. current per phase greater than 6 amps is accepted for correct performance. Contact Wallbox Service in case of doubts.

The screenshot shows the 'Power sharing' configuration screen. The 'Number of chargers' field is highlighted with a red box and is set to 1. Below it, the 'Max. current per phase' field is set to 0. The 'Min. current per charger' slider is set to 6A. The 'Dynamic power sharing' toggle is turned on. The 'Building breaker max current' field is set to 1111 and the 'Subscribed power' field is set to 0. A green 'Save' button is at the bottom.

- 9.** Define the Min. current per charger (in amps) that each charger will operate.

The screenshot shows the 'Power sharing' configuration screen. The 'Min. current per charger' slider is highlighted with a red box and is set to 6A. The 'Number of chargers' field is set to 1. Below it, the 'Max. current per phase' field is set to 0. The 'Dynamic power sharing' toggle is turned on. The 'Building breaker max current' field is set to 1111 and the 'Subscribed power' field is set to 0. A green 'Save' button is at the bottom.

CONFIGURATION

Dynamic Power Sharing

- 10.** Turn on Dynamic Power Sharing. Specify the Building breaker max current (in amps).

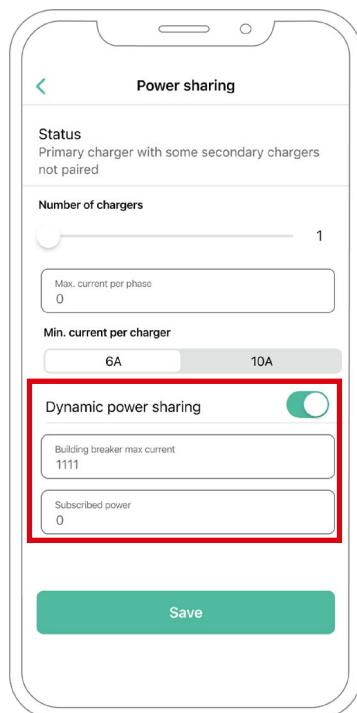

- 11.** Click Save and ensure that the status “Primary charger with all secondary chargers paired” appears.

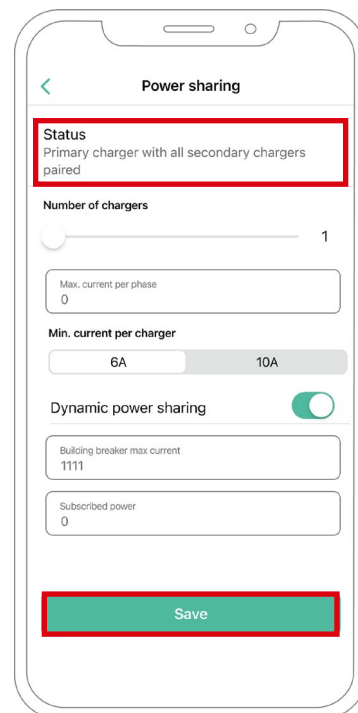

Troubleshooting steps in case the Power Sharing icon is not selectable

1. Power off and power on your charger.
2. Check all cables for correct installation.
3. Check if the correct cable type is used.
4. Check if the switch is settled correctly on “T” or “NT”.
5. Check if your charger [software](#) is up to date.
6. Make sure that you are connected through Bluetooth.

Appendix

PULSAR PLUS, PULSAR PRO, PULSAR MAX, COMMANDER 2,
COPPER SB AND PULSAR MAX

Applicable to Power Boost, Eco-Smart, V2H, Dynamic Power Sharing

EM330 Configuration

1. Press the button in the middle for 1.5 seconds to enter the password confirmation screen.

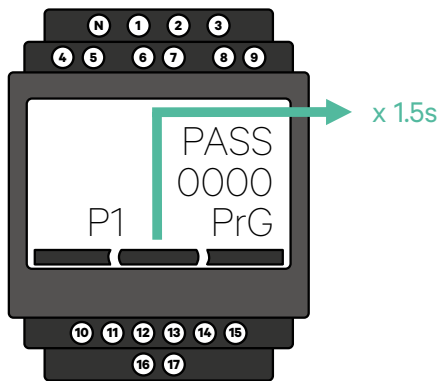

2. The pre-defined password is 0000. Just press the left and the right button at the same time to confirm.

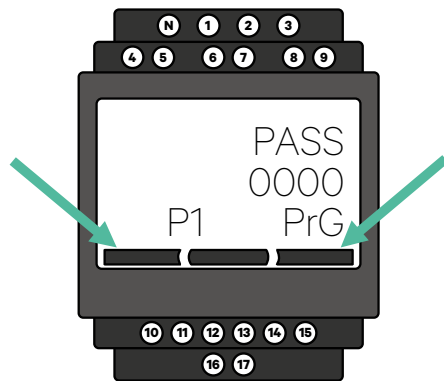

3. Using the right and left buttons, scroll up to the "Ct rAt lo" item. Press the middle button for 1.5 second and modify the value using the left and right buttons. Press the middle button to confirm the value.

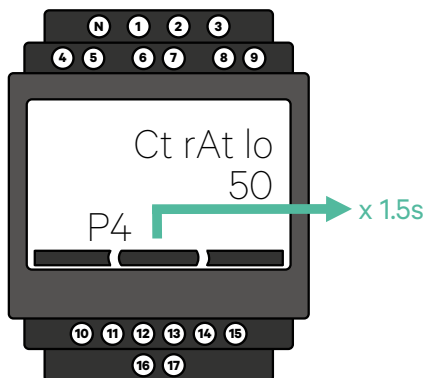

4. **FOR ECO-SMART ONLY:** Access the "MEASURE" menu. Hold down the middle button for 1.5 seconds to adjust values using the left and right buttons. Change the default "A" value to "B," then press the middle button to confirm.

5. Scroll down to the "end" option and press enter to exit the programming menu.

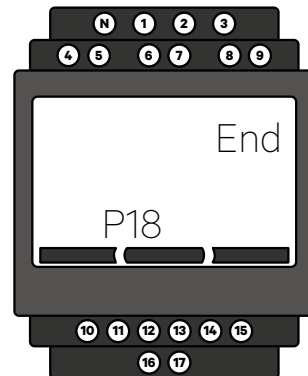

PULSAR PLUS, PULSAR PRO, PULSAR MAX, COMMANDER 2,
COPPER SB AND PULSAR MAX

How to install N1 CT

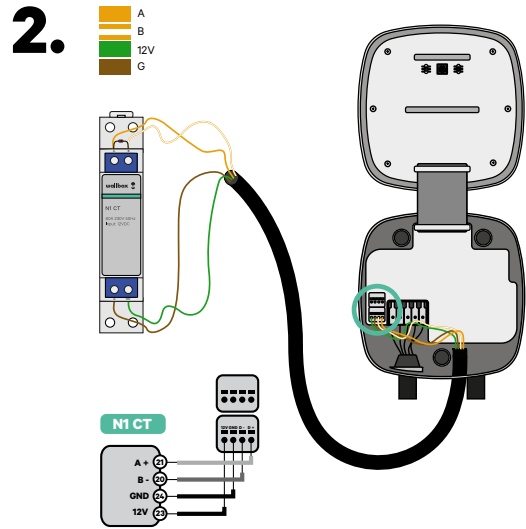
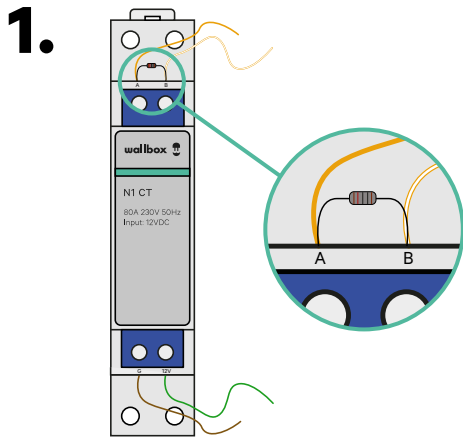

Important

Communication end resistor: the 120Ohms resistor included is to be added between the A-B connectors of the meter.

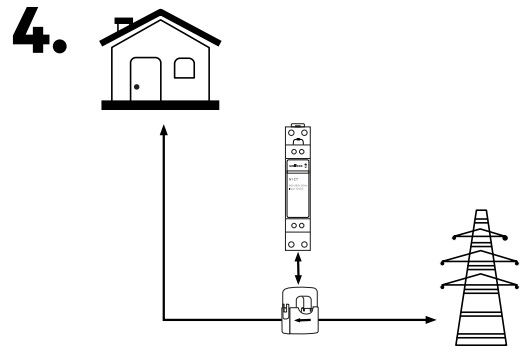
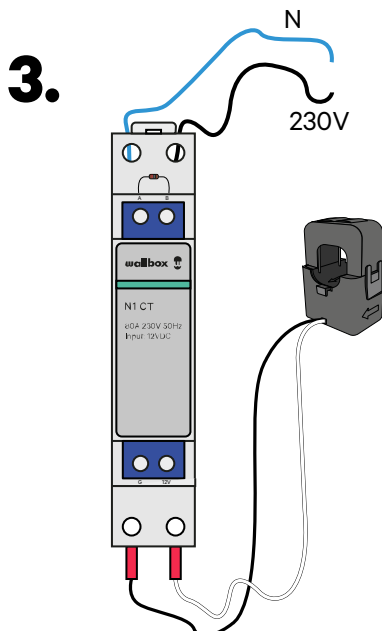

Disclaimer

The connection of the 230V AC wires is only needed when Eco-Smart is activated. This connection is not needed for activating Power Boost.

PULSAR PLUS, PULSAR PRO, PULSAR MAX, COMMANDER 2, COPPER SB AND PULSAR MAX

How to install P1 Port

1. Depending on the country, the P1 port can be already activated or not. Contact the utility company to check the status and proceed with the activation when needed.

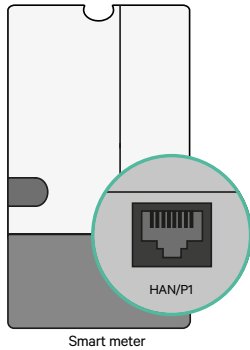

2. Fix the P1 Port meter to the DIN rail. Then, connect the RJ12 connector to the utility meter and the Wallbox P1 metering solution.

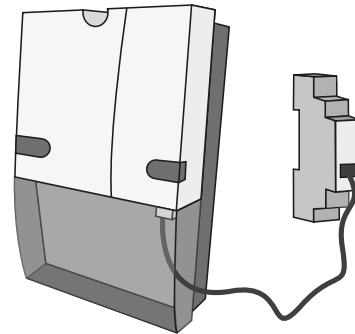

3. Look at the diagram to check how to wire P1 Port to a charger.

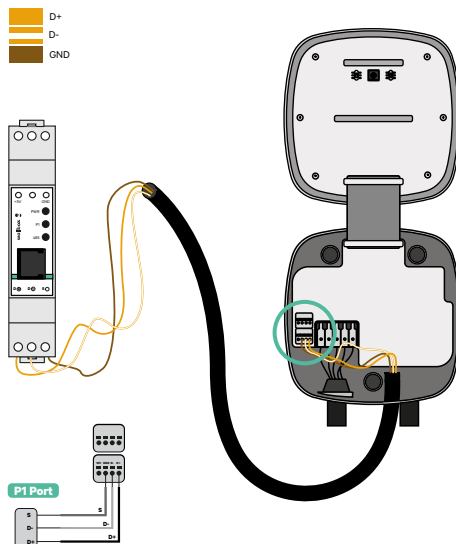

Disclaimer

The P1MB is connected via an RJ12 connection to the P1 Port. The device is powered by the +5V of the P1 Port of the connected smart meter. If not available, the P1MB can optionally be powered by an external adapter connected to the DC power interface.

How to install P1 Port

- 5.** Once the installation is completed and the charger is configured, check the P1 Port's led lights:

Power Status Led - Yellow

If the yellow light is on, the P1 Port is powered, while the device is not powered, in case the led is off.

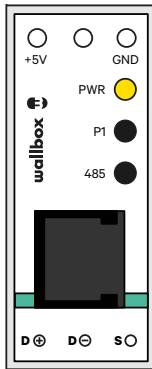

P1 Status Led - Green

If the green light is on, P1 data was received with the correct CRC. If it is off, no P1 data was received from the smart meter within the last minute.

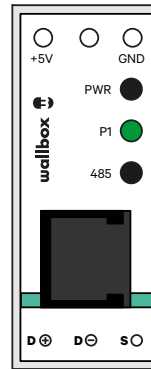

Modbus Status LED - Red

If the red light is on, a valid Modbus request was received within the last minute. If it is blinking, some data was received, but no valid Modbus request was received. If it is off, no data was received in the past 6 minutes.

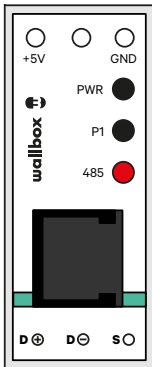

PULSAR PLUS, PULSAR PRO, PULSAR MAX, COMMANDER 2,
COPPER SB AND PULSAR MAX

Installing Dynamic Power Sharing with 4 chargers



Disclaimer

You cannot install both Pulsar Plus and Pulsar Max on the same line. However, you have the flexibility to install a combination of Pulsar Plus, Pulsar Pro, Copper SB, and Commander 2, or multiple chargers of the same models on the same line.

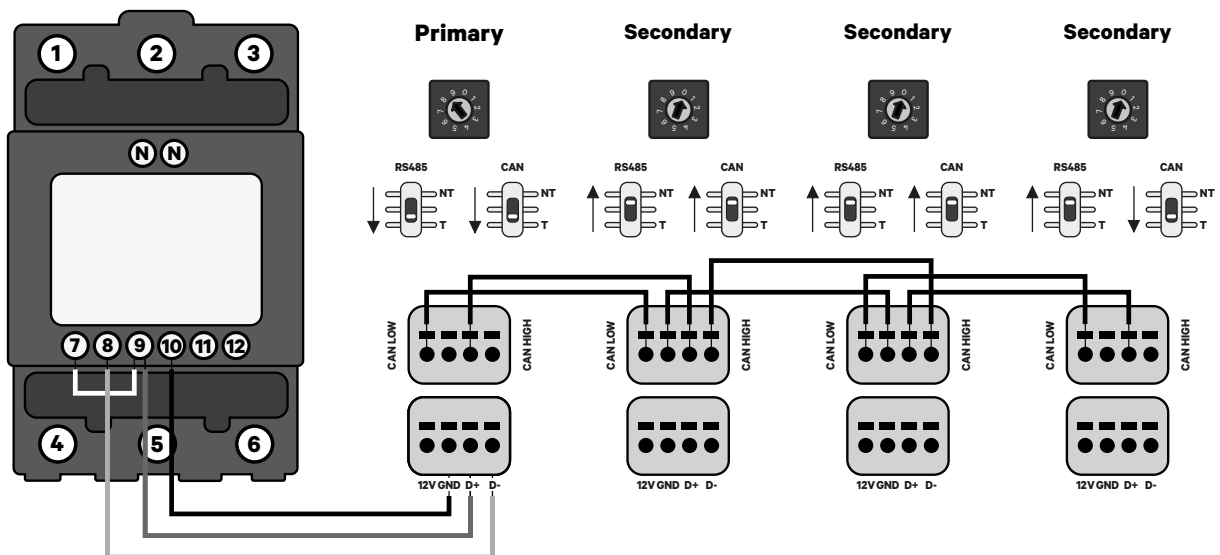



support.wallbox.com